

DP1

DEVELOPMENT PERMIT GUIDELINES: FORM AND CHARACTER

BL 18787
BL 19364

The Form and Character Development Permit Guidelines apply to all areas of the city.

DP1.1: COMMON GUIDELINES—are provided for **ALL TYPES** and, where applicable, additional guidelines also apply to the following specific development classifications:

- *Low Density Multiple Family*
- *Multiple Residential/Mixed-Use/Commercial*
- *Retail/Commercial Centres*
- *Mixed Employment/Industrial*
- *Low, Mid and High Rise Forms*
- *Signs*

DP1.2: GAS STATION GUIDELINES—are provided for both Residential and Commercial

Where a certain development type is not specifically covered in this Section, applicable guidelines should be combined and used collectively. Guidelines within this section may be further explained using graphic images which are indicated with the "*illustr.*" notation.



BL 19364
BL 21389

DP1.1

Common Guidelines: All Development Types

With specific categories generally organized as follows:

- Low Density Multiple Residential (includes Houseplexes, Townhouses, etc.)
- Multiple Residential/Mixed-Use/Commercial
- Retail/Commercial Centres
- Mixed Employment (includes Industrial, Business)
- Low-Rise (6 storeys or less), Mid-Rise (7-12 storeys) and High-Rise (more than 12 storeys)
(illustr.)

Guidelines within this section are organized into three different types:

- Site Design
- Building Form and
- Signage

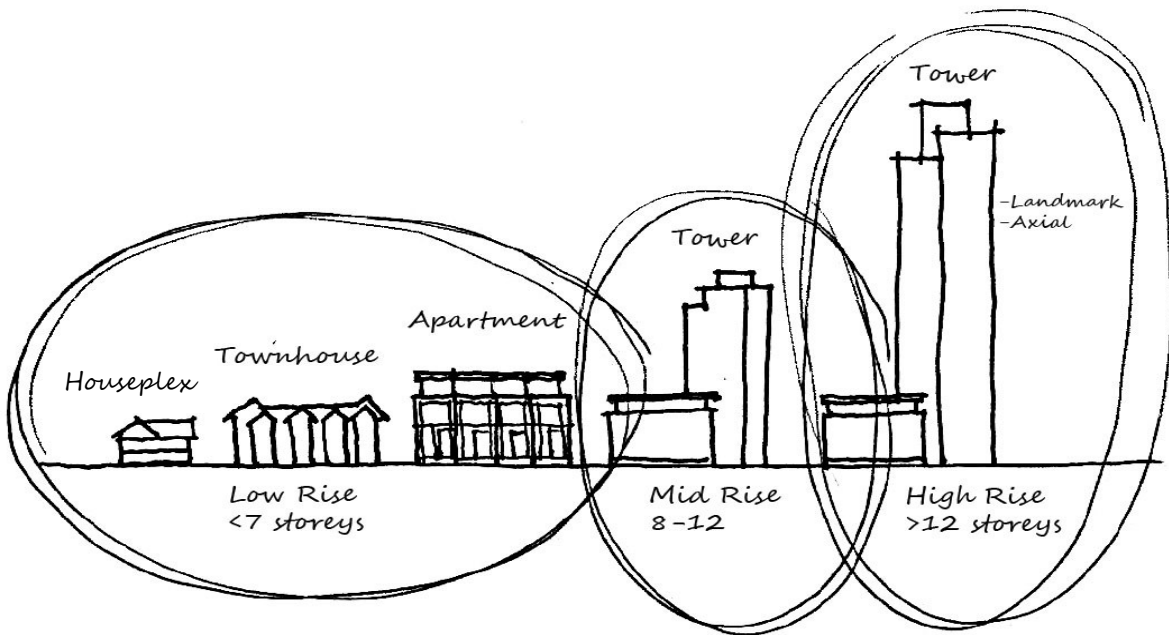

DP1.1 COMMON GUIDELINES

SITE DESIGN

General Site Design

Within a development, the following elements shall be considered in the Site Design:

1. **ALL TYPES:** Provide a transition buffer between adjoining properties containing different uses or a different intensity of uses by using design measures such as landscaping buffers and additional setbacks. (*illustr.*)
2. **ALL TYPES:** When arranging the site layout, take into consideration future intensification of densities (e.g. by clustering buildings to allow for future infill).
3. **ALL TYPES:** For any development adjacent to electrical utility wires, incorporate building setbacks that take into consideration any visual, acoustical or electromagnetic impacts while also demonstrating use of any applicable development guidelines of the utility authority.
4. **ALL TYPES:** Provide a stormwater management strategy for development sites during the early stages of design.
5. **ALL TYPES:** Locate mail facilities within amenity buildings or leave them freestanding on site near an outdoor amenity space. Incorporate weather protection using a design consistent with the overall architectural elements of the site.
6. **TOWNHOUSES:** Orient units to face the street. (*illustr.*)
7. **MIXED EMPLOYMENT:** Minimize the amount of outdoor storage.
8. **MIXED EMPLOYMENT:** Where outdoor storage cannot be avoided, locate it away from public views in rear yards with screening.
9. **MIXED EMPLOYMENT:** Consider using extensive tree coverage to screen storage areas from above views. This is particularly the case in the South Westminster area.

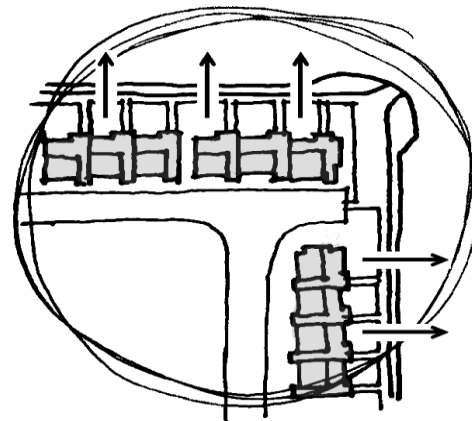

BL 21389

DP1.1 COMMON GUIDELINES

BL 20008

SITE DESIGN

Site Grading

Within a development, the following elements shall be considered in the Site Design:

10. **ALL TYPES:** Incorporate topography and other significant natural features into the building, structure and overall site design. *(illustr.)*

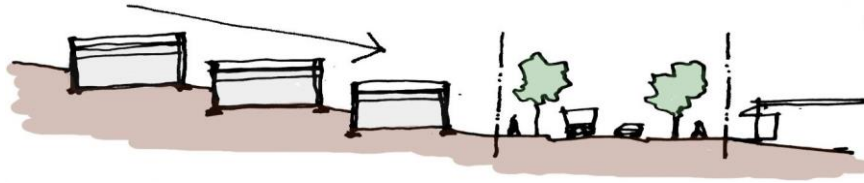

11. **ALL TYPES:** Establish a development site grading plan at the early stages of design.
12. **ALL TYPES:** Avoid excessive disruption of the natural topography of a site by stepping buildings, sloping parking areas and providing larger setbacks to avoid the use of retaining walls. When subdividing, minimal disruption of the natural topography should be accounted for in lot layout and overall subdivision design.
13. **ALL TYPES:** Where retaining walls cannot be avoided, minimize the overall height of the wall and the height of each step. Incorporate landscaping into the design of the retaining wall and use attractive materials (e.g. brick or stone masonry or sand-blasted concrete with a reveal pattern). Avoid the use of timber retaining walls, particularly where the wall is visible from the public realm.

Circulation—Pedestrian, Active and Non-Vehicular

Within a development, the following elements shall be considered in the Site Design:

14. **ALL TYPES:** Prioritize non-vehicular modes of circulation in site design (e.g. pedestrian and cycling) above all other transportation modes.
15. **ALL TYPES:** For convenience and security, provide bicycle parking facilities at-grade, close to the main building entrance or amenity buildings, and with weather protection.
16. **ALL TYPES:** Provide multiple modes of circulation on pathways to improve natural surveillance opportunities (e.g. provide a street or lane along any publically-accessible pathway).
17. **ALL TYPES:** For circulation that is accessible to all users:
 - a) Ensure pedestrian circulation is convenient, safe and clearly identifiable to drivers and pedestrians
 - b) Use a high standard of accessible and adaptable design to accommodate the functional needs of all individuals including children, adults, seniors, and those with visual, mobility or cognitive challenges
 - c) Locate convenient universal access to buildings from parking areas by using curb let-downs or other accommodating features
 - d) Provide a minimum of 1.8 m unobstructed sidewalk width to accommodate strollers, wheel-chairs and other equipment used by pedestrians.
 - e) Clearly define accessible routes from parking stalls to building entry doors and locate accessible parking closest to the main entry of a building (surface parking) or elevator lobby entrance

DP1.1 COMMON GUIDELINES

SITE DESIGN

Circulation—Pedestrian, Active and Non-Vehicular *(cont.)*

Within a development, the following elements shall be considered in the Site Design:

18. **ALL TYPES:** Where a development directly abuts a transit stop, allow for additional building setbacks to accommodate pedestrian volumes. Create a comfortable experience for pedestrians by including amenities and features such as visual art, drinking fountains, lighting and street furniture.
19. **ALL TYPES:** Provide physical links from the development to public sidewalks, pathways and transit stops. When subdividing, these connections should be accounted for in lot layout and overall subdivision design. *(illustr.)*
20. **ALL TYPES:** Incorporate beautification and amenity features along pedestrian pathway systems (e.g. use distinctive and durable paving, special landscaping with trees, furniture and/or weather protection).
21. **ALL TYPES:** When shopping cart storage is necessary, provide for convenient use and return. Allow for clearances surrounding cart corrals for pedestrians and vehicles and design the structure to be in keeping with the character of other site structures and furnishings.
22. **ALL TYPES:** For circulation through surface parking areas:
 - a) Provide direct, functional and safe pedestrian pathways through parking areas allowing for convenient connections to the sidewalks of abutting streets
 - b) Extend contrasting, durable concrete sidewalk paving treatments where pathways extend through vehicle circulation areas
 - c) Incorporate a hierarchy of primary and secondary pathway systems throughout the development site
 - d) Provide a minimum of 3 m wide sidewalks along primary pedestrian pathways at active building frontages to allow for tree clearances and weather protection overhangs



DP1.1 COMMON GUIDELINES

BL 20008

SITE DESIGN

Circulation—Vehicular

Within a development, the following elements shall be considered in the Site Design:

23. **ALL TYPES:** Enhance connectivity of public roads and lanes through development sites by establishing public thoroughfares for pedestrians, cyclists and vehicles.
24. **ALL TYPES:** Provide joint or shared driveway and ramp access between adjacent sites and consider driveway connections to future adjacent development sites.
25. **ALL TYPES:** Locate driveways off minor streets or lanes rather than off major streets to enhance a safe, walkable streetscape. *(illustr.)*
26. **ALL TYPES:** Where there is no alternative to providing access from a major street, locate and design driveways to minimize disruption of the pedestrian environment along the street by minimizing the number of driveways, by sharing access points and by maintaining a continuous street orientation of the development.
27. **ALL TYPES:** Where private roadways are proposed in-lieu of public streets, provide and design boulevard, landscaping and sidewalk treatments to be similar to or mimic those found along public roadways.
28. **ALL TYPES:** Consider accommodating residential and/or short-term parking along lanes rather than on streets where it tends to interrupt or interfere with pedestrian sidewalk movements.
29. **ALL TYPES:** Create markers at site perimeter driveway entrances.
30. **ALL TYPES:** For vehicular circulation in surface parking areas:
 - a) Provide vehicle connections between adjacent surface parking areas from neighbouring sites
 - b) Ensure parking is located away from street frontages or from street corners
 - c) Divide large surface parking areas into smaller sections defined by buildings or driveways with a sidewalk and landscaping on each side
 - d) Orient parking rows perpendicular to main entrances with a driveway along the building frontage for safer pedestrian movements
 - e) Locate accessible parking spaces close to main building entrances and/or elevator lobbies
 - b) Ensure accessible parking spaces are barrier-free by:
 - Including curb letdowns in practical locations
 - Locating any pole-mounted signage so it does not obstruct vehicle loading
 - Providing clearance from landscaping so it does not obstruct vehicle loading

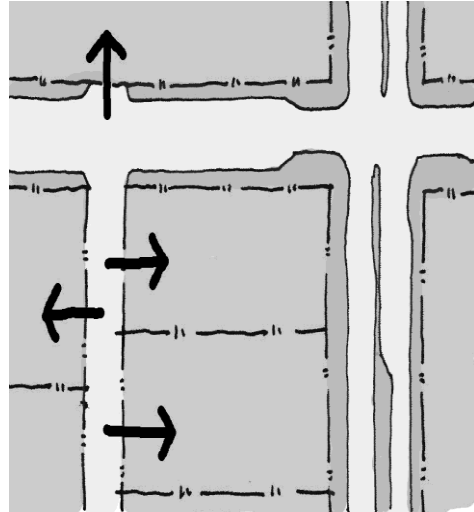

DP1.1 COMMON GUIDELINES

SITE DESIGN

Circulation—Vehicular (cont.)

Within a development, the following elements shall be considered in the Site Design:

31. **ALL TYPES:** For parking ramps *(illustr.)*:
- Where ramps cross sidewalks, provide a maximum five percent (5%) slope for the first 6 m of the ramp
 - Provide specialty paving for the first 6 m
 - Set parking ramps back from side property lines by a minimum of 1.5 m to allow for a land-scaped buffer
 - Treat sidewalls of ramps with specialty details and finishing (e.g. sand blasting with a reveal pattern).

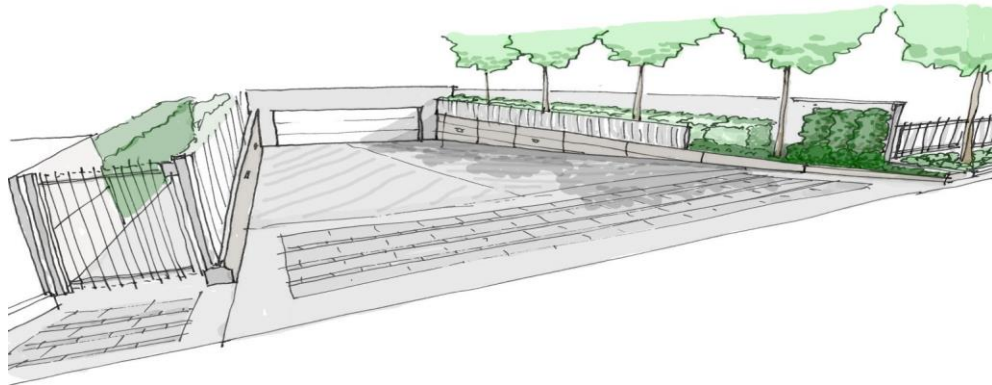

32. **ALL TYPES:** For site loading:
- Locate surface loading spaces away from public views; screen and pave with specialty materials
 - Loading may need to be fully enclosed to reduce acoustical impacts on adjacent residential areas
 - Gates may be necessary for closure during non-business hours
 - Maneuvering for loading should be provided and accommodated for completely on-site, not on streets.
33. **TOWNHOUSES:** Screen apron parking that is visible from the public realm.
34. **TOWNHOUSES:** Use side-by-side parking as the main provision for parking and specifically minimize the use of tandem parking.
35. **MULTIPLE/MIXED/COMMERCIAL:** For corner store residential units, locate surface residential parking close to the residential entrance for convenience and security.
36. **INDUSTRIAL and BUSINESS:** Reduce conflicts between heavy vehicles and traffic from visitors and employees.
37. **INDUSTRIAL and BUSINESS:** Locate movements for heavy vehicles away from residential interfaces, where possible, and incorporate features to mitigate noise, fumes and visual intrusion; in some cases, an impact study may be required.

DP1.1 COMMON GUIDELINES

SITE DESIGN

Site Landscaping

Within a development, the following elements shall be considered in the Site Design:

- 38. **ALL TYPES:** Identify, preserve and incorporate healthy stands of mature trees into the overall site landscaping design. *(illustr.)*
- 39. **ALL TYPES:** Retain unique or culturally or historically important trees or vegetation and nesting areas on the development site.
- 40. **ALL TYPES:** Provide a coordinated group of furnishings to match the overall character of the development and site features, (e.g. bike racks, signs, garbage enclosures, benches, waste receptacles and tree grates).
- 41. **ALL TYPES:** Site landscaping design should consider the context of surrounding properties where there is a dominant pattern along the street (e.g. provide tree rows and landscaping consistent with the established or emerging standards along the street or within an adjacent neighbourhood).
- 42. **ALL TYPES:** Use landscaping and landscape materials to conform to the most current version of the British Columbia Society of Landscape Architects/British Columbia Landscaping and Nursery Association's *British Columbia Landscape Standards* (as amended).
- 43. **ALL TYPES:** Ensure sufficient in-ground planters are provided for full, healthy tree growth. *(illustr.)*
- 44. **ALL TYPES:** Locate trees no closer than 2 m from a building face, building foundation or retaining wall. Use only small growing tree species between 2 m to 3 m from the building setback; use medium growing tree species between 3 m and 4 m; and use large growing tree species beyond 4 m.



DP1.1 COMMON GUIDELINES

SITE DESIGN

Site Landscaping (cont.)

Within a development, the following elements shall be considered in the Site Design:

45. **ALL TYPES:** Site landscaping should incorporate environmentally sustainable features:
- Minimize stormwater runoff and reduce heat island effects (e.g. increase the amount of land-scaped areas on-site and decrease the amount of impervious paved surfaces)
 - Take energy efficiency into consideration in the overall design of landscaped areas. Use designs that moderate the effect of wind and solar impacts on buildings (e.g. use deciduous trees along western and southern building frontages to address passive solar gains and allow for winter gains) (*illustr.*)
 - Minimize high water use mown turf areas. Strive to limit mown turf areas to a maximum of 25-50% of the total landscaped area of one site
 - Reduce evaporation from soil by providing mulches to shrubs and groundwaters
 - Use the highest quality plant material possible and in a scale and massing that will have an obvious impact; maximize the function and aesthetic qualities of landscaping for open spaces
 - Select plants that require less need for chemical interventions in pest and weed control.
46. **ALL TYPES:** For landscaping in surface parking areas:
- Locate curbed landscape islands throughout parking areas in order to define parking clusters, visually break-up and screen the parking area, highlight pedestrian routes, increase human comfort, provide shade and manage stormwater opportunities
 - Locate landscaped islands as such: between, and at the end of, parking rows; one landscaped island along the side of a parking space, at the end of every six spaces in a single row; one land-scaped island, at a minimum of 3.6 m in length, located along the end of each group of 6 paired spaces (e.g. 12 spaces in two adjoining rows of 6 spaces, each front to front)
 - Cluster small car spaces with left over areas used for a landscaped island
 - Provide a minimum of 1.5 m radius for tree root balls in landscaped islands. Where a 1.5 m radius cannot be provided, the minimum landscape strip width should be not less than 1 m. Structural soil should be used under paved areas for the smaller landscaped strip to protect the roots from vehicles
 - Incorporate wheel stops or other devices in parking spaces to prevent landscaping and tree trunks from vehicle damage
 - Maximize tree spacing appropriately to correspond with the mature size of the tree species being used; allow for at least one tree in each island
 - Use single stem deciduous shade trees with a minimum of 5 cm caliper or larger, with tree canopies that begin no less than 2 m above grade
 - Use a mix of #1, #2 and #5 plant pot sizes for shrubs in landscaped islands as well as a mix of evergreen trees or plant material that will provide for year-round variety
 - Allow for visual surveillance through the site between the low shrubs screening the bottom half of the vehicles and the bottom of the tree canopy
 - Locate lower shrub plantings at crossing points to ensure visibility between vehicles and pedestrians at crossings.

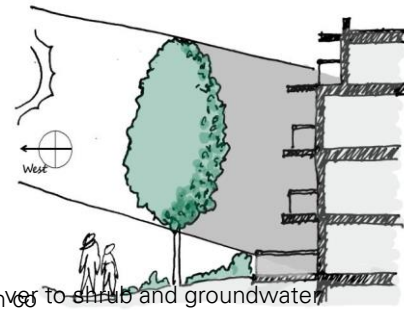

DP1.1 COMMON GUIDELINES

BL 21389

SITE DESIGN

Site Landscaping (cont.)

Within a development, the following elements shall be considered in the Site Design:

- 47. **TOWNHOUSES:** Provide landscaping at each individual entrance and between parking along private driveways.
- 48. **INDUSTRIAL and BUSINESS:** Locate a stormwater management swale in the front yard setback with associated planting.
- 49. **INDUSTRIAL and BUSINESS:** Provide sufficient landscape buffering where adjacent to residential development, include features such as berms, solid residential-type fencing where it will be visible and dense conifer planting.
- 50. **INDUSTRIAL and BUSINESS:** Where security fencing is necessary, avoid barbed or razor wire; work to integrate hedging along a fence line.

Site Services

Within a development, the following elements shall be considered in the Site Design:

- 51. **ALL TYPES:** Provide screening of and locate electrical kiosks and gas meters away from the visible public realm. *(illustr.)*

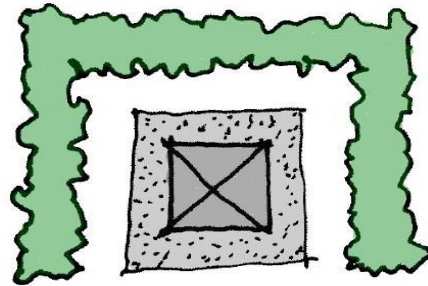

- 52. **ALL TYPES:** Where refuse containers cannot be located in underground facilities, locate enclosures away from the visible public realm.

- 53. **ALL TYPES:** Design refuse enclosures to coordinate with the overall design of the development and use the same high quality, durable materials as the rest of the site. Refuse container storage should have secure gates and a roof.



- 54. **ALL TYPES:** Provide a room or area large enough to allow for multiple types of refuse containers. Ensure sufficient room is created on-site to accommodate composting and recycling facility as well as garbage disposal.

- 55. **ALL TYPES:** Locate underground parking mechanical vents away from the visible public realm and make flush with grade.

DP1.1 COMMON GUIDELINES

SITE DESIGN

Site Lighting

Within a development, the following elements shall be considered in the Site Design:

- 56. **ALL TYPES:** Incorporate neighbourhood character elements into on-site lighting design.
- 57. **ALL TYPES:** Provide a hierarchy of different lighting types with a coordinated appearance (e.g. lower- scale pedestrian pathways, parking areas, drive aisles, building and site entrances, and larger-scale parking lot lighting).
- 58. **ALL TYPES:** Coordinate the location of lighting with other landscape elements (e.g. trees).
- 59. **ALL TYPES:** Ensure overall site lighting enhances public safety and accommodates for safe ease of pedestrian movements to and from the development site.
- 60. **ALL TYPES:** Incorporate energy efficiency into the overall lighting plan.
- 61. **ALL TYPES:** Design and install lights that are vandal proof. Take maintenance accommodations into consideration when designing development site lighting plans.
- 62. **ALL TYPES:** Provide exterior street lighting that follows the *International Dark Sky Model* (as amended) in order to limit light pollution and to reduce light overspill into any adjacent residential areas. (*illustr.*)
- 63. **COMMERCIAL:** Incorporate lighting poles fitted for hanging baskets with associated irrigation and banners.
- 64. **INDUSTRIAL and BUSINESS:** Locate lighting to assist visual surveillance including site security (e.g. monitored cameras).

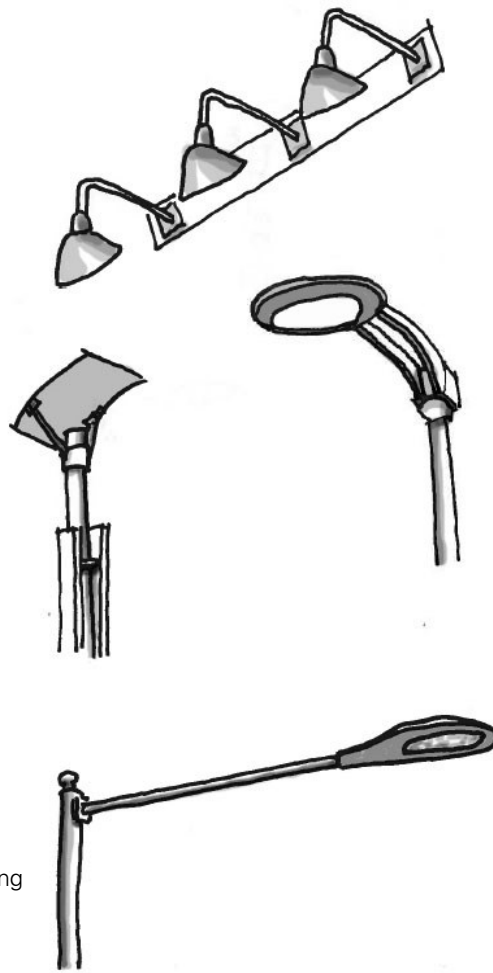

DP1.1 COMMON GUIDELINES

BL 19946

SITE DESIGN

Shared Amenity Space

Within a development the following elements shall be considered in the Site Design:

- 65. **ALL TYPES:** Provide sufficient outdoor amenity space at a scale consistent with the size of the development and in consolidated, usable spaces.
- 66. **ALL TYPES:** Provide a covered, weather protected outdoor seating area.
- 67. **ALL TYPES:** Provide shade trees at seating areas for summer comfort.
- 68. **ALL TYPES:** Provide a variety of passive and active program spaces.
- 69. **ALL TYPES:** Provide opportunities and support facilities for urban agriculture (e.g. provide a water source, tool storage and composting facilities).
- 70. **ALL TYPES:** Locate outdoor amenity spaces near indoor amenity rooms, entrances or staff areas, (e.g. lunch rooms) to encourage the observation and engagement of outdoor spaces.
- 71. **ALL TYPES:** Provide forms of hard and soft landscaping (e.g. constructed planters, gazebos, trellises and pergolas) to enhance the usability of decks, balconies and other outdoor amenity spaces.
- 72. **ALL TYPES:** Use roof tops as an additional outdoor amenity space.
- 73. **RESIDENTIAL:** Secure play areas for children that are located where they can be easily observed and that allow for a variety of play experiences. Children play areas should be landscaped and paved for surface play.
- 74.1 **TOWNHOUSES:** Outdoor amenity space should be useable for play and activities; and for townhouse developments less than 25 units, should not include tree protection areas.
- 74.2 **RESIDENTIAL:** Provide a minimum of one indoor amenity per residential building.
- 74.3 **MID-RISE RESIDENTIAL:** Provide a minimum of one indoor amenity per residential building or per 80 grouped residential units, whichever is less.

Publically Accessible Open Space

Within a development the following elements shall be considered in the Site Design:

- 75. **ALL TYPES:** Create publically accessible open spaces on private property along streets, lanes and public thoroughfares to add amenity spaces and enjoyment to urban areas. *(illustr.)*
- 76. **ALL TYPES:** The amount and scale of open space provided should reflect both the density of the neighbourhood and of the immediate area (e.g. on larger sites in denser neighbourhoods, larger open spaces should be provided).
- 77. **ALL TYPES:** Publically accessible open space should be added, in addition to any shared outdoor amenity space



DP1.1 COMMON GUIDELINES

SITE DESIGN

Publically Accessible Open Space (cont.)

Within a development the following elements shall be considered in the Site Design:

78. **ALL TYPES:** Open spaces should be defined as to its purpose and function by:
 - a) Incorporating passive activities in the design (e.g. providing seating as a basic function)
 - b) Contributing to placemaking by creating a focal point for visual interest
 - c) Enhancing the green, natural experience by incorporating stormwater management features into the design
 - d) Incorporating other functions into larger open spaces (e.g. playground areas).

79. **ALL TYPES:** Open spaces should be located with consideration given to the surrounding area and site by:
 - a) Linking with other open spaces in the area
 - b) Taking advantage of any unique vegetation, views or riparian areas
 - c) Responding to access for all seasons (e.g. lunch time for area workers)
 - d) Responding to wind (e.g. by providing shelter)
 - e) Reducing the impact of noisy locations (e.g. by mitigating the negative impacts of traffic by using water features)
 - f) Shaping open spaces to respond to a surrounding context (e.g. by widening a promenade in order to reinforce a street or by extending a corner plaza to link with a main building entrance)
 - g) Maximizing public access to open spaces by locating them along at least two public streets
 - h) Locating rest areas adjacent to a greenway and along highly visible locations (e.g. at intersections with connecting streets or other greenways).

80. **ALL TYPES:** Incorporate detailed design and landscape elements:
 - a) Define public, private and semi-public spaces adjacent to open spaces by using low landscaping
 - b) Incorporate local character, cultural themes or art work as a focal point or as an integral part of the overall design
 - c) Plant large trees, in clusters if possible, that have adequate growing medium and space, particularly where the trees are located on parking structures
 - d) Add shade trees suitable to prevent summer overheating
 - e) Create opportunities for open space uses, especially for children to engage in nature within an urban setting
 - f) Use trees, shrubs, ground covers, vines and flowers in a variety of colors and textures to reflect seasonal changes and variation
 - g) Install lawns to help visually soften the surrounding urban environment and to serve as an inviting and effective dry-weather seating area
 - h) Consider adding electrical and water access points for events held in larger open space areas
 - i) Use surface materials that allow for universal accessibility, particularly allowing for easy access by the elderly or disabled
 - j) Provide integrated stormwater features within landscaped areas
 - k) Ensure material selection, design, layout and function of the space is done with the objective of maintaining long term attractiveness
 - l) Incorporate subtle pedestrian-scale lighting into the character and overall design of the open space.

DP1.1 COMMON GUIDELINES

SITE DESIGN

Publically Accessible Open Space (cont.)

Within a development the following elements shall be considered in the Site Design:

81. **ALL TYPES:** Program the open space to be active and safe by:
- a) Designing the open space to connect with people moving through the area, including along de- sire lines
 - b) Maximizing surveillance of open space areas, (e.g. by orienting main entrances, townhouses or shop fronts onto the open space and by avoiding interfacing open spaces with parking lots)
 - c) Encouraging indoor uses to spill out onto open spaces (e.g. by creating informal outdoor seating areas and by creating space for the commercial display of goods)
 - d) Providing good visibility from surrounding public areas or streets by: minimizing walls, minimiz- ing raised planters, locating plazas at street level, creating seamless connections to streets and by creating clear sightlines across the open space (*illustr.*)



- e) Considering all users of a space (e.g. consider how unintended users such as skateboarders, may conflict with passive users)
- f) Considering the quality of the open space at different times of the day and week and for different seasons (e.g. by using lighting to adjust comfort in an open space).

DP1.1 COMMON GUIDELINES

SITE DESIGN

Publically Accessible Open Space (cont.)

Within a development the following elements shall be considered in the Site Design:

- 82. **TOWNHOUSES:** Create a publically accessible open space at street corners. *(illustr.)*

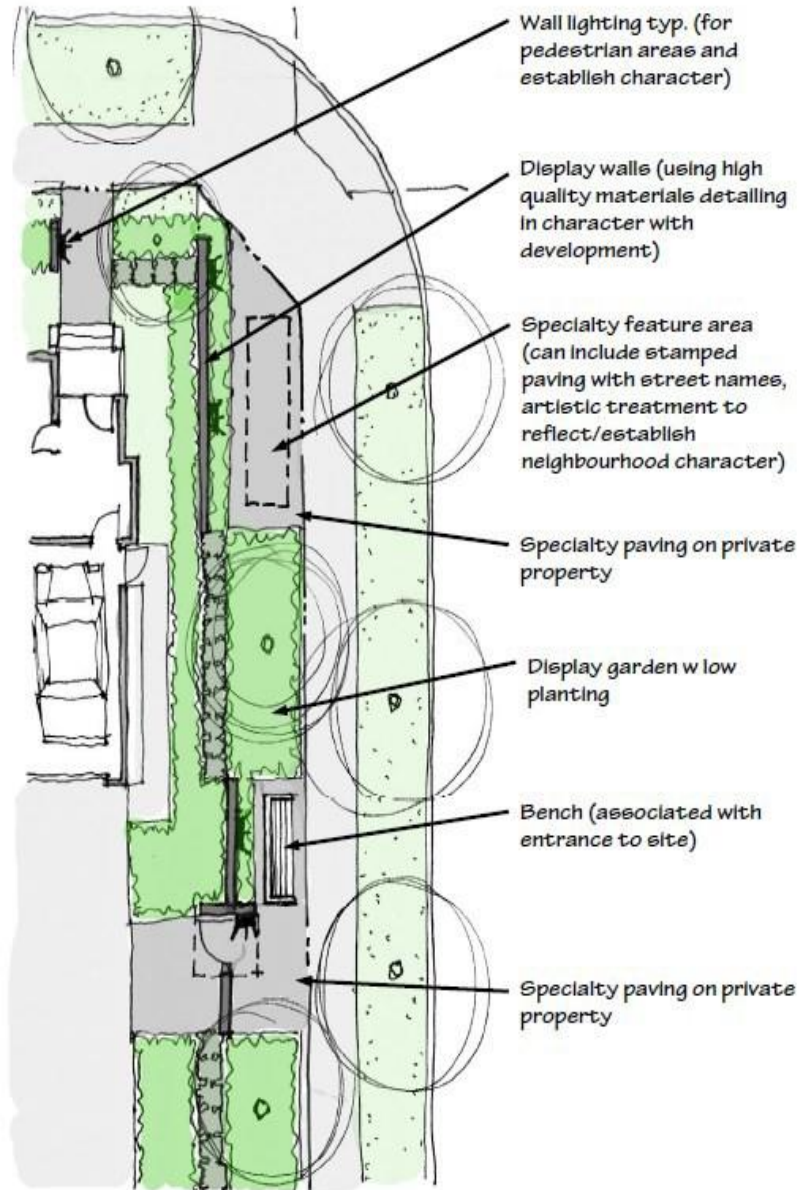

DP1.1 COMMON GUIDELINES

BL 19765

SITE DESIGN

Public Realm and Street Interface

Within a development, the following elements shall be considered in the Site Design:

- 83. **ALL TYPES:** Enhance beautification opportunities along prominent transportation routes, heritage streets, boundary streets and City gateways.
- 84. **ALL TYPES:** To better coordinate the interface between public and private property, include information on design drawings about off-site and adjoining public property elements (e.g. show sidewalks and boulevard details designed to City standards for reference). Set the ultimate grade requirements of adjacent public property at the early stages of design.
- 85. **ALL TYPES:** Coordinate continuous front yard setbacks along streets, particularly where buildings abut one another with no side yard, such as in Town Centres or along prominent shopping streets.
- 86. **ALL TYPES:** Enrich the public realm and street interface with distinctive character elements such as art features and cultural and historical references.
- 87. **ALL TYPES:** Underground parking should be set back and lowered, especially where visible in the public realm, so as to not project above grades; include allowances for tree roots, soil and paving depths.
- 88. **ALL TYPES:** Trees should be set back 0.5 m from any public thoroughfare property line to facilitate access, maintenance and root growth.
- 89. **ALL TYPES:** Where driveway entrances divert to each side, consider the axial view down the driveway by providing a landscaped feature or marker at the end of the driveway.
- 90. **ALL TYPES:** Screen all parking areas visible from the street with a landscaped buffer a minimum of 3 m wide. Provide a minimum of a double staggered row of evergreen shrubs, with a minimum height of 1 m, and deciduous trees with canopies starting at a minimum of 2 m above grade, spaced to meet the mature tree size. Landscaped buffers for shared vehicle parking stalls should also be a minimum of 3 m wide but landscaping should not obstruct visibility of the stalls from the street or public walkways. Provide low, open, decorative fencing with solid posts using durable materials such as masonry, and incorporate it to better define parking areas and focused pedestrian routes throughout the site.
- 91. **RESIDENTIAL:** Step planters up to raised patios with a maximum of 0.6 m wall height with high quality material facing such as masonry (e.g. stone or brick) or specialty concrete and low, layered planting in front of the wall. *(illustr.)*
- 92. **RESIDENTIAL:** Enhance each individual entrance with a tree planted in ground and specialty treatments as gate markers.
- 93. **RESIDENTIAL:** Enhance the progression from the sidewalk to the front door by lining up stairs straight

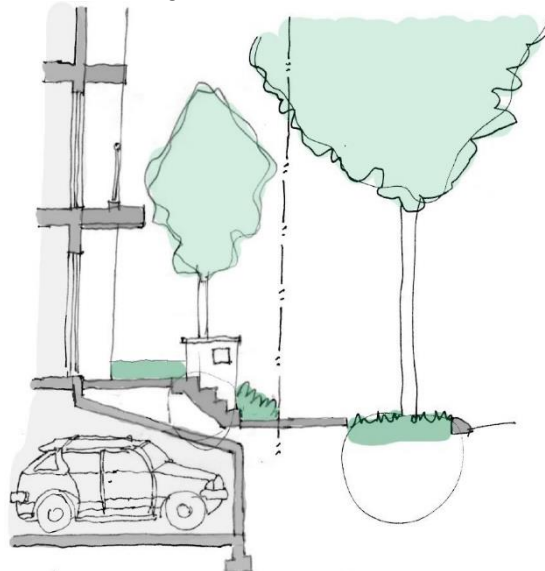

DP1.1 COMMON GUIDELINES

BL 21389

SITE DESIGN

Public Realm and Street Interface *(cont.)*

Within a development the following elements shall be considered in the Site Design:

- 94. **COMMERCIAL:** Incorporate the following elements *(illustr.)*:
 - a) Seamless interfaces should be created across public and private property without using steps or retaining walls
 - b) In-ground planting should be provided along street edges; avoid the use of raised planters
 - c) Reinforce a formal tree-lined promenade along a street by providing an inside row of trees, on private property, where there is a setback of 2.5 m or more.

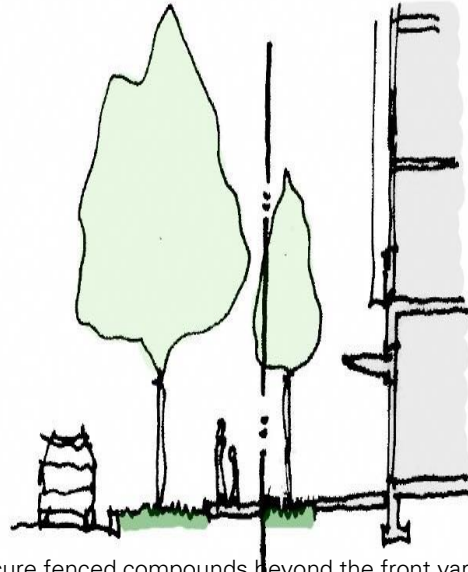

- 95. **INDUSTRIAL and BUSINESS:** Define and secure fenced compounds beyond the front yard to avoid having a fenced front yard.
- 96. **INDUSTRIAL and BUSINESS:** Provide a setback from the property line to allow for landscaped buffers along the building. *(illustr.)*

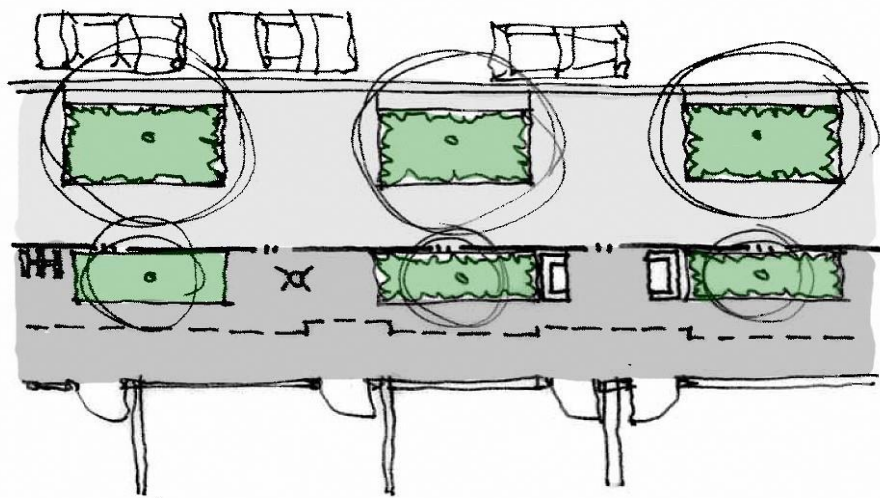

DP1.1 COMMON GUIDELINES

BUILDING FORM

Building Ground Plane Interface

Within a development the following elements shall be considered in the Building Form:

- 97. **ALL TYPES:** Step building ground floor levels to match the adjacent sidewalk grades on sloping sites. *(illustr.)*
- 98. **ALL TYPES:** Maximize the number of individual entrances to the street and public areas. *(illustr.)*



- 99. **ALL TYPES:** Create a strong sense of main entrance that is architecturally integrated with the building and that is facing the primary street.
- 100. **ALL TYPES:** Set main building entrances at the sidewalk grade without the need for transitions such as steps or ramps. Incorporate steps or ramps inside the main entrance lobby.
- 101. **ALL TYPES:** Locate active uses to face streets and non-active uses to face away from streets to avoid blank walls facing the public realm.
- 102. **ALL TYPES:** Provide a setback from the property line to allow for a landscape buffer along the building. Use facade variations, textured surfaces, architectural detailing or graphics and colours to reduce visual impact of blank walls.
- 103. **ALL TYPES:** Incorporate lighting into the building to enhance entrances, adjacent streets and public spaces for pedestrians.
- 104. **ALL TYPES:** Establish natural surveillance opportunities along publically accessible circulation routes by encouraging active uses to locate adjacent to the edge.
- 105. **RESIDENTIAL:** Specific to residential interfaces, the following elements should be applied:
 - a) Orient the main floor levels with the adjacent sidewalk grade, setting at a minimum of 0.6 m and a maximum of 1.2 m above grade
 - b) Express a strong individual entry porch at the street level with weather protection over each entrance
 - c) Orient front doors and front porches to face the street.
- 106. **TOWNHOUSES:** Incorporate a habitable room associated with the front entrance for units facing a street or public thoroughfare.

DP1.1 COMMON GUIDELINES

BUILDING FORM

Building Ground Plane Interface (cont.)

Within a development the following elements shall be considered in the Building Form:

- 107. **COMMERCIAL:** Incorporate the following elements:
 - a) Maximize active uses (e.g. shop fronts) along the public interface, including along streets and public thoroughfares
 - b) Orient primary retail or commercial unit entrances towards the street rather than to parking areas
 - c) Locate large retail units away from street edges. Where large retail buildings along street edges cannot be avoided, infill smaller retail units along these frontages (*illustr.*)
 - d) Maximize retail/commercial glazing at the street frontage and avoid overhanging building arcades.

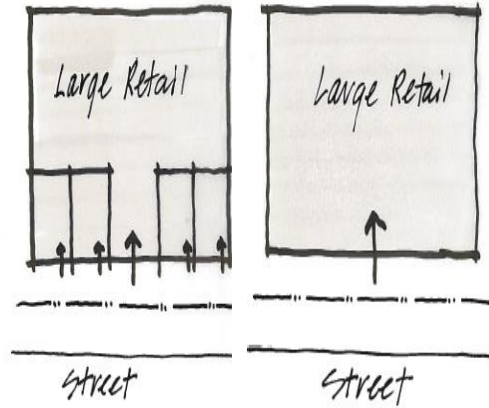

- 108. **COMMERCIAL:** The following elements should be applied (*illustr.*):
 - a) Express the individuality of each unit with unique features to break down the scale of long facades
 - b) Provide a finer grain of detailing of ground level frontages to add interest and character
 - c) Provide deeper weather protection on buildings that are adjacent to transit stops.



- 109. **INDUSTRIAL and BUSINESS:** Locate loading doors away from public realm interfaces.
- 110. **INDUSTRIAL and BUSINESS:** Where there is no alternative to locating doors away from facing streets, provide specialty design of loading doors and integrate design into the architectural elements of the overall building.
- 111. **INDUSTRIAL and BUSINESS:** Express the ground floor along the street architecturally to establish scale.

DP1.1 COMMON GUIDELINES

BUILDING FORM

Building Massing

Within a development the following elements shall be considered in the Building Form:

112. **ALL TYPES:** Create a comparable building scale and massing with the established and/or known future neighbourhood.

113. **ALL TYPES:** Follow incremental development of an area over time to avoid sudden large-scale changes.

114. **ALL TYPES:** Orient and shape buildings to reduce shadow impacts on outdoor spaces. *(illustr.)*

115. **ALL TYPES:** Create building forms with a strong street enclosure, particularly at corners.

116. **ALL TYPES:** Locate higher building forms along more prominent streets and at corners.

117. **ALL TYPES:** Address prominent and axial sites by shaping buildings for their visual prominence and potential as reference points or landmarks.

118. **ALL TYPES:** Reduce the visual impact and massing of enclosed elevator shafts with architectural treatments.

119. **ALL TYPES:** Express vertical circulation (e.g. stairs and atria) as an architectural element.

120. **ALL TYPES:** Enhance large, flat expanses of roof (whether actively used or not) with texture, colour and/ or landscaping.

121. **ALL TYPES:** Orient buildings to line streets including angled and curved streets. *(illustr.)*

122. **ALL TYPES:** For wider streets (e.g. arterials), create a higher podium to respond to street enclosure proportion.

123. **ALL TYPES:** Where higher density forms are proposed adjacent to or across the street from single family areas, design and scale the building size and massing down to that of the single family forms.

124. **ALL TYPES:** Locate elevators internal to the building and incorporate the mechanical penthouse into roof forms.

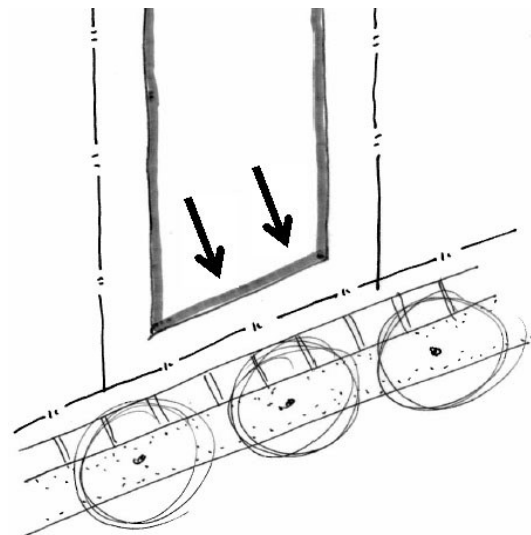

DP1.1 COMMON GUIDELINES

BUILDING FORM

Building Massing (cont.)

Within a development the following elements shall be considered in the Building Form:

- 125. **TOWNHOUSE:** Scale townhouse buildings with multiple units to a maximum footprint of 600 sq. m or six units.
- 126. **RESIDENTIAL:** Articulate larger roof forms by varying height and using dormers.
- 127. **MULTIPLE/MIXED/COMMERCIAL:** Visually scale down the length of the podium massing to 50 m by stepping down the roof forms and indenting the facade. *(illustr.)*

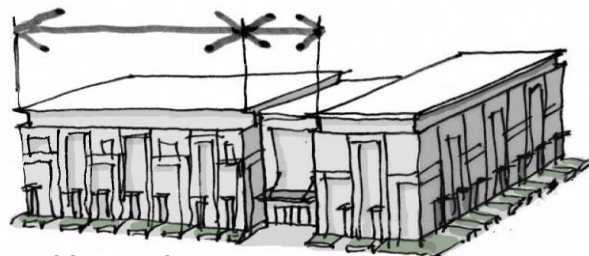

- 128. **MULTIPLE/MIXED/COMMERCIAL:** Step back portions of the upper storeys for buildings higher than 3 storeys. The lower storeys should maintain street enclosure. Where townhouses are incorporated into the base of the building, express the 2 storey form in the lower tower floors. *(illustr.)*
- 129. **RETAIL and COMMERCIAL:** Provide an enclosed service corridor at the rear of multi-tenant buildings to avoid the need for an outdoor walkway, particularly where visible to the public realm or adjacent to residential uses.
- 130.a **LOW RISE FORMS:** Optimize views, light and air for units in low rise buildings by providing minimum separations between buildings to achieve the following:
 - 1) between a building side and another building side—minimum of 6 m;
 - 2) between a building side and a building front—minimum of 12 m;
 - between a building front and another building front—minimum of 20 m when one of the buildings is 50 m wide or less and a minimum of 24 m wide when one of the buildings is more than 50 m wide. *(illustr.)*

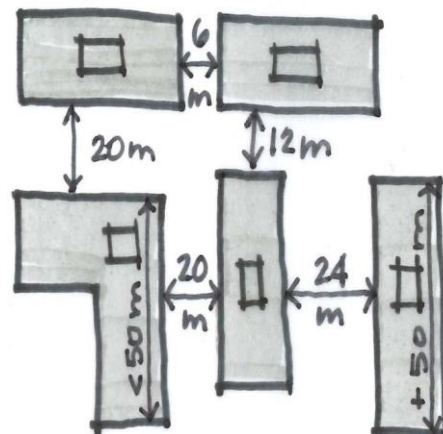

- 130.b **MID RISE FORMS:** Tower separations from corner-to-corner should be a minimum of 20 m and from face-to-face a minimum of 30 m.
- 131. **HIGH RISE FORMS:** Cluster high-rise towers with the highest forms in the core and taper out to lower forms at the outside of the cluster.
- 132. **HIGH RISE FORMS:** Minimize the east-west dimension width to 28 m for shadowing.

BL 19364
BL 20292
BL 20389

BL 19364
BL 20292

DP1.1 COMMON GUIDELINES

BUILDING FORM

Building Massing (cont.)

Within a development the following elements shall be considered in the Building Form:

- 133. **HIGH RISE FORMS:** Scale residential floors relative to tower height with high-rise floor plates at a: 1) maximum of 600 sq. m for buildings up to 30 storeys; 2) maximum of 650 sq. m for buildings between 31—40 storeys; 3) maximum 700 sq. m for buildings 41—50 storeys; 4) and maximum 750 sq. m for buildings 51 storeys and higher.
- 134. **HIGH RISE FORMS:** Set tower orthogonal to the street for the majority of sites.
- 134.a **HIGH RISE FORMS:** Tower separation is a minimum of 30 m from corner-to-corner and a minimum of 50 m from face-to-face. *(illustr.)*
- 135. **HIGH RISE FORMS:** Locate towers to allow views through from surrounding sites and from within the site for multi-tower sites.
- 136. **HIGH RISE FORMS:** Incorporate features which reduce the impacts of wind (e.g. balconies and articulation on tower forms which capture and slow the wind at upper levels).
- 137. **HIGH RISE FORMS:** Reinforce street enclosure by setting towers close to the street with approximately 4 m set back from the podium face and integrating the tower as it meets the podium form.
- 138. **HIGH RISE FORMS:** Form tower tops into an expression of the roof function (e.g. roof gardens).
- 139. **HIGH RISE FORMS:** Create a 4-6 storey podium as a base to the higher tower forms and reinforce street enclosure. *(illustr.)*

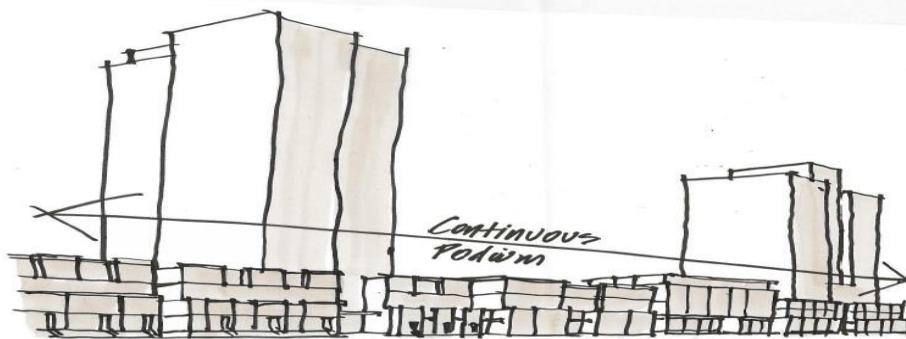
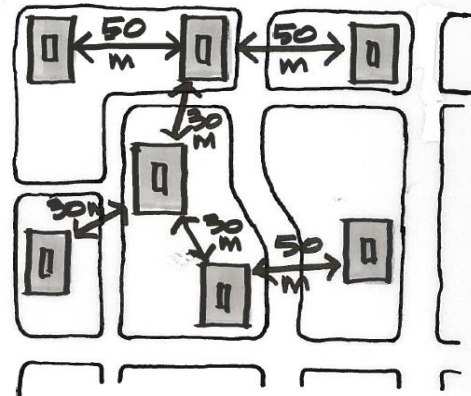

- 140. **INDUSTRIAL and BUSINESS:** Locate buildings on sites to allow views through from upland residential areas and to screen views of any outdoor storage areas.
- 141. **INDUSTRIAL and BUSINESS:** Express the different functions of the building (e.g. entrances, second floor office areas, and warehouses) as distinct forms by varying the parapet heights and by stepping forms rather than using an arbitrary application of building variations.
- 142. **INDUSTRIAL and BUSINESS:** Ancillary or secondary buildings should be designed to the same architectural level as the principal building.

DP1.1 COMMON GUIDELINES

BUILDING FORM

Architectural Character, Treatment and Materials

Within a development the following elements shall be considered in the Building Form:

143. **ALL TYPES:** Select exterior building materials for their functional and aesthetic quality. These materials should exhibit high qualities of workmanship, durability, longevity and ease of maintenance.
144. **ALL TYPES:** Continue higher quality materials used on the principal façade around any building corner or edge which is visible to the public. (*illustr.*)



145. **ALL TYPES:** Avoid the excessive use of monotone colour palettes.
147. **ALL TYPES:** Design any visible side walls with visual interest by using such features as texture, color, graphics, wall art and lighting.
147. **ALL TYPES:** For underground parking and above-ground parkades:
- Where interconnected between sites, parking structures should be separate and secure
 - Separate large parking facilities into smaller secured areas
 - Provide direct access to the street for retail parking and access to the elevator in underground parking for visitors
 - Provide overhead gates to underground parking areas; secure residential parking from non-residential parking
 - Locate exit stairs from underground parking within the building envelope and make flush with the building face without alcoves
 - Freestanding exit/access stairs and elevators to parking should be fully enclosed, visibly open and expressed as an architectural element with vandal resistant materials
 - Design exit vestibules and elevator lobbies with clear visibility such as glass enclosures
 - Parking interiors should be painted with light colors to improve visibility and lighting efficiencies
 - Parking interiors should be visibly open with few walls, hidden corners and alcoves
 - Provide accessible common areas for storage, refuse and recycling material
 - Secure bicycle parking facilities, storage lockers and change rooms with showers
 - Above-ground parkades should be wrapped with active uses along public frontages. Where visible, design as a primary façade using durable, high quality materials with the main entrance strongly expressed
 - Control access to parkades with secured exit stairs and access to the ground level where only the parking ramp is left open allowing for tighter access control.

DP1.1 COMMON GUIDELINES

BUILDING FORM

Architectural Character, Treatment and Materials (cont.)

Within a development the following elements shall be considered in the Building Form:

- 148. **ALL TYPES:** Incorporate options for mounting cellular equipment and incorporate screening to avoid visual clutter on the tops of buildings, particularly for higher buildings.
- 149. **ALL TYPES:** Minimize the potential for bird collisions when siting buildings near existing landscape features and when planning new landscapes in close proximity to buildings by doing the following:
 - a) Creating visual markers on buildings by using a denser pattern of glass, applying patterns, film, decals, decorative grills and louvers to glass surfaces
 - b) Angling glass to project reflected images downward, and
 - c) Installing awnings or overhangs to cover windows on the ground floor of a building.
- 150. **ALL TYPES:** Indicate measures taken to enhance building performance and consider designing new buildings to a green building standard (e.g. LEED or equivalent).
- 151. **ALL TYPES:** Incorporate environmentally sustainable green building features such as:
 - a) Utilizing sustainable construction methods and materials, including the reuse, rehabilitation, restoration and recycling of building and/or building elements
 - b) Minimizing summer solar gain (e.g. south and west facing) by using roof overhangs, balconies, awnings, louvers, canopies and other window screening techniques *(illustr.)*
 - c) Maximizing winter solar gain, (e.g. by using solar water heating or solar mass walls)
 - d) Installing green roofs
 - e) Improving indoor air quality
 - f) Minimizing the impact of adverse weather on buildings and on the street-level microclimate (e.g. strive to reduce excessive heat by providing generous shade)
 - g) Reducing water consumption (e.g. by using reclaimed or recycled water or rainwater capture from roofs or rain barrels for outdoor use) when available, and as a substitute for potable water
 - h) Improving the energy performance and energy consumption of HVAC systems by using alternative energy supplies (e.g. photovoltaics and wind power).

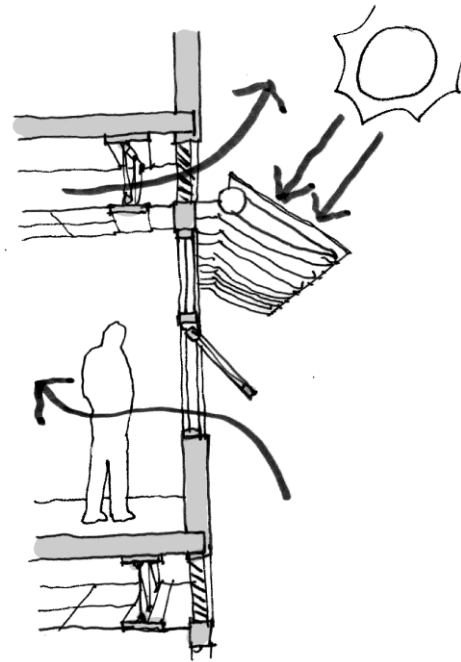

DP1.1 COMMON GUIDELINES

BL 18787

BUILDING FORM

Architectural Character, Treatment and Materials (cont.)

Within a development the following elements shall be considered in the Building Form:

152. **ALL TYPES:** Incorporate energy efficient building design features such as:
- a) **Adjusting Compact Massing and Form**—minimize loss of heating energy by reducing the number of corners and joints use in a building by incorporating simple, solid shapes (e.g. rectangles or cubes) *(illustr.)*



- b) **Exterior Shading**—minimize unwanted solar gains during the summer (e.g. by using horizontal shading devices on the south and east facades) and optimize solar heat gain in the winter (e.g. by using vertical shading devices on west facades) *(illustr.)*

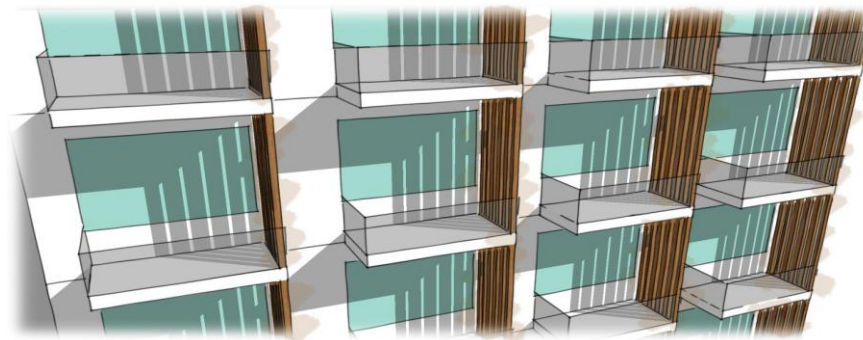

- c) **Window Frame Detailing**—mitigate heat loss by reducing the use of excessive or unnecessary design features (e.g. design buildings with fewer, larger windows that reduce excessive use of

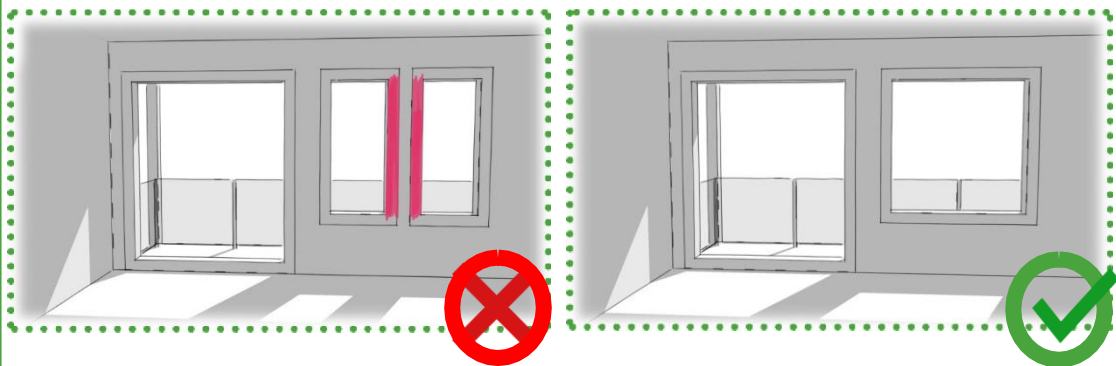

DP1.1 COMMON GUIDELINES

BL 18787

BUILDING FORM

Architectural Character, Treatment and Materials (cont.)

Within a development the following elements shall be considered in the Building Form:

- d) **Adjusting Window Fenestration**—avoid floor-to-ceiling glazing by ensuring bottom window sill heights are placed at a minimum of 24 inches above the floor to block unnecessary solar radiation at foot level. *(illustr.)*
- e) **Thermal Bridging**—mitigate heat loss through the building envelope by constructing thermally-broken balconies from the building (e.g. ensure wall insulation is continuous, minimizing heat loss) *(illustr.)* or by eliminating exposed

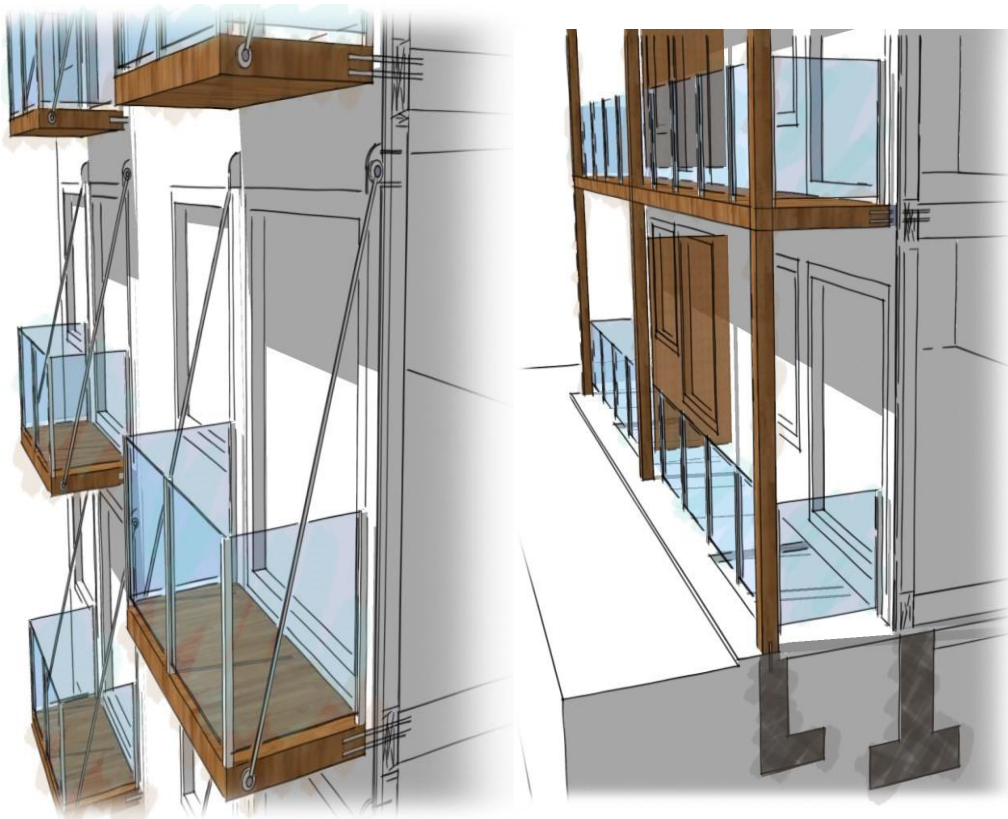
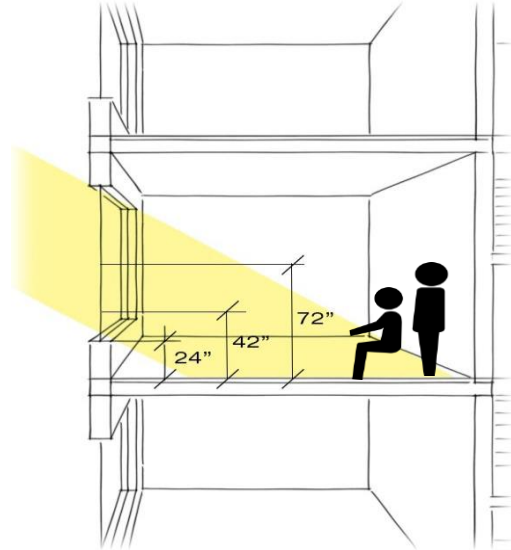

BL 18787

DP1.1 COMMON GUIDELINES

BUILDING FORM

Architectural Character, Treatment and Materials (cont.)

Within a development the following elements shall be considered in the Building Form:

153. **TOWNHOUSES:** Incorporate features on corner unit sides such as entrances, bay windows and roof articulation (e.g. gable ends). *(illustr.)*

154. **TOWNHOUSES:** Provide wider window trim and vary the type of materials used at different levels of the unit (e.g. use masonry at the base, siding on main levels and treat the gable ends with specialty materials).

155. **TOWNHOUSES:** Emphasize the vertical expression and identification of individual units.

156. **TOWNHOUSES:** Design firewalls to be incorporated into the overall building so they are not visible through roof forms.

157. **RESIDENTIAL:** Break down façades into smaller scale elements through the use of windows, bays, balconies and dormers.

158. **RETAIL and COMMERCIAL:** Pitched roof forms shall have full roof expression rather than being truncated.

159. **INDUSTRIAL and BUSINESS:** Prefabricated buildings are generally discouraged. Should they be used, significant building improvements will be required to achieve an adequate and acceptable architectural design. Incorporating extensive use of glass (e.g. transparent and spandrel) into the design may offset the solid nature of the buildings reaching a more acceptable design level.

160. **INDUSTRIAL and BUSINESS:** Consolidate roof mechanical units together and screen from views.



Residential Livability

Within a development the following elements shall be considered in the Building Form:

161. **ALL RESIDENTIAL:** For residential development directly abutting an arterial road, a report with recommendations prepared by persons trained in acoustics and current technologies of noise measurements shall be provided that demonstrates that noise levels for specific portions of a dwelling unit are not exceeded. Those noise levels and specific portions of a dwelling unit include:
- a) Bedrooms—35 decibels
 - b) Living, dining and recreation rooms—40 decibels
 - c) Kitchens, bathrooms and hallways—45 decibels.

For the purposes of this guideline, “Noise Level” is defined as the A-weighted, 24-hour equivalent (Leq) sound level defined in decibel levels.

DP1.1 COMMON GUIDELINES

BL 18787
BL 19765

BUILDING FORM

Residential Livability (cont.)

Within a development the following elements shall be considered in the Building Form:

- 162. **ALL RESIDENTIAL:** Take into account the negative acoustical impacts that can result when residential uses are located along roadways, (e.g. arterial roads) and when residential and non-residential uses are mixed within the same development. Use methods that will help to buffer residential units from external noises including:
 - a) Orienting bedrooms and outdoor areas away from obvious noise sources
 - b) Providing mechanical ventilation to allow for the choice of keeping windows closed
 - c) Enclosing balconies or using sound-absorptive materials and sound barriers
 - d) Using sound-deadening construction techniques or materials (e.g. concrete, acoustically-rated glazing or glass block walls)
 - e) Locating areas not affected by noise (e.g. stairwells and single-loaded corridors) between the noise source and the dwelling unit.
- 163. **ALL RESIDENTIAL:** Include a window in each bedroom to provide daylight and ventilation for occupants.
- 164. **TOWNHOUSES:** Incorporate privacy screening between patios and balconies.
- 165. **TOWNHOUSES:** Provide a minimum of 15 m for rear yard privacy between townhouse buildings.
- 166. **MULTIPLE/MIXED/COMMERCIAL:** Orient residential units to face front or rear yards, not side yards or parking ramps. (*illustr.*)

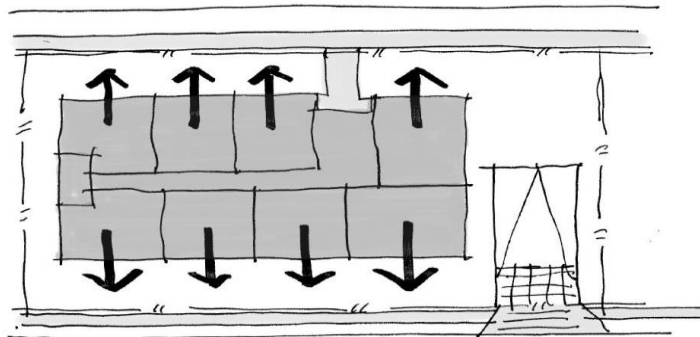

- 167. **MULTIPLE/MIXED/COMMERCIAL:** Design residential corridors with a maximum distance of 30 m from a unit to an elevator.
- 168. **MULTIPLE/MIXED/COMMERCIAL:** Provide an elevator for approximately every 70 units for convenience.
- 169. **MULTIPLE/MIXED/COMMERCIAL:** Where stairs are located at the elevator lobby and at the end of a corridor, design stairs to be visible, open and larger than the minimum to encourage walking. The number of units per elevator, as noted in DP Guideline 1.1.170, can be increased when building design encourages walking.
- 170. **MULTIPLE/MIXED/COMMERCIAL:** Where exit stairs and lobbies have exterior walls, incorporate windows for daylighting.
- 171. **MULTIPLE/MIXED/COMMERCIAL:** Locate mail boxes to be visible to residents. They should be fully visible to the residential elevator rather than located in an enclosed space.
- 172. **MULTIPLE/MIXED/COMMERCIAL:** In mixed-use developments, design buildings to ensure that each different use is self-contained and has a separate entrance with a focus on security

DP1.1 COMMON GUIDELINES

BL 18787
BL 19765

SHARED VEHICLES

Location

Within a development, the following elements shall be considered for accommodating Shared Vehicles:

- 173. Locate shared vehicles at-grade on private property to achieve convenient access and visibility from the street or lane. Integrate shared vehicle parking stalls with landscaping without obstructing visibility.
- 174. Locate multiple shared vehicles together on each site.
- 175. Cluster parallel parking of shared vehicles, where provided in a Green Lane, to no more than two stalls unless landscaped islands are provided every 18 m. *(illustr.)*

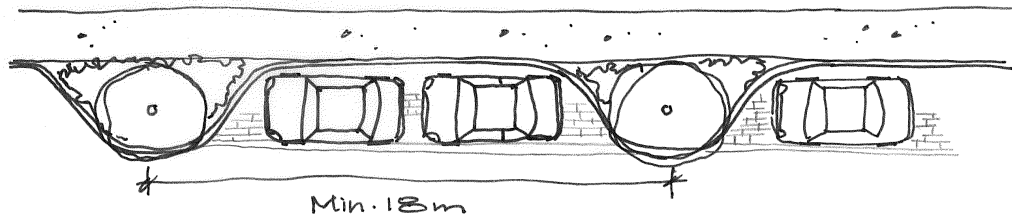

- 176. Provide safe pedestrian access to shared stalls with a minimum 1.5 m walkway.
- 177. Ensure shared vehicle parking stalls do not impede the normal functions of a laneway (e.g. utility access, garbage collection, etc.).

Lighting

Within a development, the following elements shall be considered for accommodating Shared Vehicles:

- 178. Incorporate vandal-proof lighting in the landscaping to provide ease of access to shared vehicles with- out creating glare to adjacent residential units.

Signage

Within a development, the following elements shall be considered for accommodating Shared Vehicles:

- 179. Locate shared vehicle parking signs at the designated stall discreetly and without the use of backlit sign boxes.
- 180. When shared vehicles are located in a parking structure, provide signage at the parking structure entrance to identify where stalls are located. Sign specifications shall be in accordance with the Surrey Sign Bylaw, as amended.

Appearance

Within a development, the following elements shall be considered for accommodating Shared Vehicles:

- 181. Treat at-grade shared vehicle stalls with distinctive, durable paving (e.g. pavers) and incorporate into the site landscaping.
- 182. Minimize additional paved areas required for shared vehicle stalls by sharing drive-aisles with other parking areas and by maintaining efficient circulation.
- 183. Avoid building additional free-standing structures to accommodate shared vehicles in order to reduce building mass.

DP1.1 COMMON GUIDELINES

BL 18787

SIGN GUIDELINES

Definitions

In conjunction with the City of Surrey Sign Bylaw, as amended, the following definitions outline and illustrate common signs related to Development Permit guidelines for Signs:

- Awning/ Canopy Sign** A sign painted on, attached to, or constructed on the surface of an awning or canopy, providing weather protection beyond a roof eave, that may include letters, characters, graphics and numbers.
- Fascia Sign** A sign displayed on a building face on a plane generally parallel to the face of a building.
- Freestanding Sign** A sign attached to the ground that is independent of any building or structure located on the same lot. Also known as Pylon Sign or Monument Sign.
- Individual Panels** On free-standing signs, the separate panels used by tenants to advertise within a multi-tenant building.
- Portable Changeable Copy Sign** Any sign not permanently attached to the ground or a building on which the information displayed can be changed manually or automatically using detachable letters, characters, numbers, pictorial panels or graphics.
- Projecting Sign** A sign attached to and projecting outward from the face of a building. Does not include wall, canopy or fascia signs. Also known as a Blade Sign. *(Illustr.)*
- Sandwich Board** Non-illuminated, portable sign having an "A" shape which is set upon the ground and has not external support elements.
- Sign Copy** Individual letters, characters, graphics or numbers on a sign either with or without lighting. Also known as Cut- Out, Channel, Stencil-Cut and/or Routed Letters. *(Illustr.)*

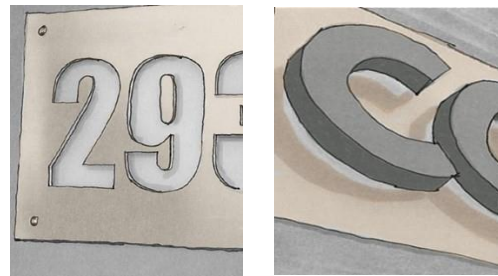

DP1.1 COMMON GUIDELINES

SIGN GUIDELINES

BL 18787
BL 19765

General Design

In conjunction with the City of Surrey Sign Bylaw, as amended, the following design elements, where applicable, are required for sign installations:

- 184. All signage must conform to the regulations and standards as established in the City of Surrey Sign Bylaw, as amended.
- 185. Signs shall be made of durable, weather-resistant and high-quality materials.
- 186. All signs shall be professionally designed and fabricated with a high degree of design and aesthetics.
- 187. Signs shall consider the pedestrian realm as a priority in design, size and placement. *(Illustr.)*
- 188. A complete sign package is required to be submitted with building elevations for development permits. Sign packages should include signs that are directed toward the pedestrian realm with an appropriate scale and location suitable for comfortable pedestrian viewing (e.g. under-awning and projecting signs).
- 189. Where multiple signs exist on one property signs should have a coordinated design.
- 190. Where multiple signs exist on larger sites, sign size, location and design should ensure a coordinated hierarchy with a variety of sign types placed so as to reduce visual clutter and to reduce domination by anchor tenants.
- 191. Using contrast, or other design features, signs should be easily and universally readable.
- 192. Building lighting bands should not dominate building architecture. *(Illustr.)*
Building lighting bands should be designed with the following features:
 - one muted colour with halo-type lighting versus using a back-lit box
 - lower level luminaries or bulbs to reduce potential glare
 - simple horizontal bands with no vertical banding
 - bands that are shorter in length and smaller in size.
- 193. All wiring should be located within an approved conduit which is integrated fully with a sign or that is completely concealed.



DP1.1 COMMON GUIDELINES

BL 18787
BL 19765

SIGN GUIDELINES

General Design *(cont.)*

In conjunction with the City of Surrey Sign Bylaw, as amended, the following design elements, where applicable, are required for sign installations:

194. Signs should not dominate the architecture of the building. *(Illustr.)*



195. Sign lighting should be designed with the following features:
- cut-off shields to reduce light spill into residential areas
 - LED lighting to reduce overall glare
 - light sources that are not exposed, excludes neon tubes
 - elements that do not flash or that are animated
 - consistency with the lighting levels identified in the International Dark Sky Model
 - energy-efficient materials.

Sandwich Board

Within a development, the following elements shall be considered for Sign installations:

196. Primarily used for 2nd floor tenants located at the lower entrance areas.
197. No changeable copy signs are permitted on sandwich board signs.
198. Sandwich Board signs shall be coordinated with other on-site signage and used primarily for tenants located in upper floors. *(Illustr.)*
199. Shall be located to minimize interference with pedestrian thoroughfares, and are preferably located as close to the building as possible. Sandwich board signs are not permitted on public property.
200. Sign materials and installation shall be able to withstand the effects of wind and weather by using appropriate materials and weighting measures.

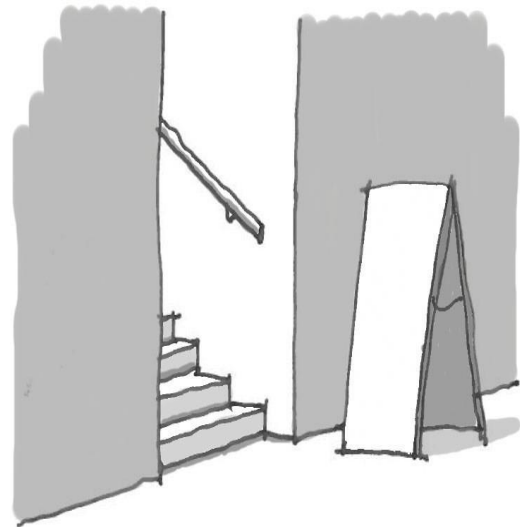

DP1.1 COMMON GUIDELINES

BL 18787
BL 19765

SIGN GUIDELINES

Free-Standing

In conjunction with the City of Surrey Sign Bylaw, as amended, the following design elements, where applicable, are required for sign installations:

201. Businesses located at the rear of a property and not visible from the street shall be given signage priority in a multi-tenant freestyle sign. Where all businesses are visible, a free-standing sign is not encouraged.
202. Within the free-standing sign, the number of individual signs shall be minimized to reduce visual clutter. Six tenant signs per side should/shall be the maximum. (*Illustr.*)

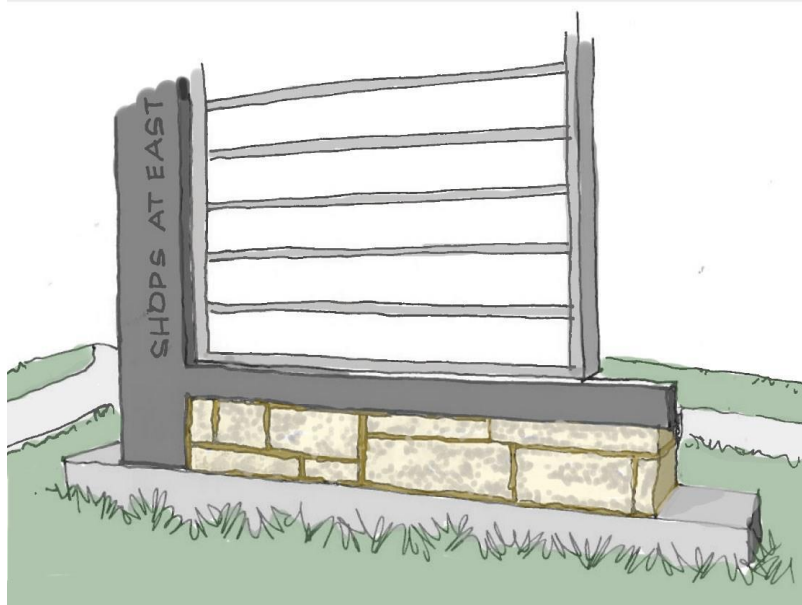

203. Individual signs should be muted colour blank backing rather than white (when not leased). Bright colour schemes for individual signs shall be minimized.
204. Background colours should complement the architectural colour scheme of the building or overall development. When blank areas are present on a sign, those blank areas should also reflect the architectural colour scheme of the building or overall development rather than remaining white.
205. Design sign heights to be oriented toward pedestrian environments, particularly in areas evolving away from previously auto-oriented site designs. Signs should be designed as appropriate to the site and surrounding areas rather than automatically being constructed to meet the maximums as established in Surrey Sign Bylaw, as amended.
206. Use the top feature of a free-standing sign to tie the character of the sign with that of the architecture of the building or with other character elements of the surrounding neighbourhood.
207. Avoid the use of repeating the same style and design for sites where multiple signs are permitted. Use a variety of colours and styles to create variety, interest and uniqueness to a development.
208. Free-standing signs should be a monument style shape where the base width is consistent with the full extent of the rest of the sign and where the bottom is not narrower than the rest of the sign.

DP1.1 COMMON GUIDELINES

BL 18787
BL 19765

SIGN GUIDELINES

Free-Standing (cont.)

Within a development, the following elements shall be considered for Sign installations:

- 209. Placement of the address on the top of the freestanding sign is encouraged. *(Illustr.)*
- 210. Use aesthetically-pleasing materials and detailing for sign bases such as architectural concrete or masonry.
- 211. Install landscaping around the base of free-standing signs. Landscaping should be layered, with lower plants in the front and higher plants closer to the sign base and consistent in plant species, design, layout and Best Management Practices to that used throughout the rest of the development. *(Illustr.)*
- 212. Changeable copy lettering or designs are discouraged from being used on or with free-standing signs.



Miscellaneous

Within a development, the following elements shall be considered for Sign installations:

- 213. Projecting and/or blade signs shall be two-sided and professionally designed and may be cast, routed, built up, sculpted or lettered. *(Illustr.)*
- 214. Inflatable signs are not permitted.
- 215. Sign variety is encouraged, particularly for sites with multiple buildings or for an over-all development. Signs using the following design elements, in place of back-lit, flat-face sign boxes, are encouraged:
 - non-illuminated individual letters with remote illumination
 - halo-lit individual letters
 - under-awning signage



DP1.1 COMMON GUIDELINES

BL 18787
BL 19765

SIGN GUIDELINES

Lighting

Within a development, the following elements shall be considered for Sign installations:

- 216. Encourage architectural lighting on the face of commercial buildings and at main entrances to residential buildings to help create a sense of safety and intimacy around the building.
- 217. Gooseneck lights and sconces that are applied to fascias underneath weather protection elements are preferred for storefront lighting. *(Illustr.)*



- 218. Ensure lighting is sensitive to nearby residential uses. Avoid visible, glaring light sources by using down-lights or up-lights with cut-off shields. *(Illustr.)*
- 219. Incorporated valence lighting should be placed into canopies and up-lighting to illuminate pathways.
- 220. Encourage the use of LED lighting for storefronts.
- 221. Sign illumination shall be designed to limit light pollution and reduce light spill-over into adjacent residential areas. The International Dark Sky Model (as amended) shall be used as reference to determine appropriate lit levels for signs. Minimize sign lighting by using indirect lighting.

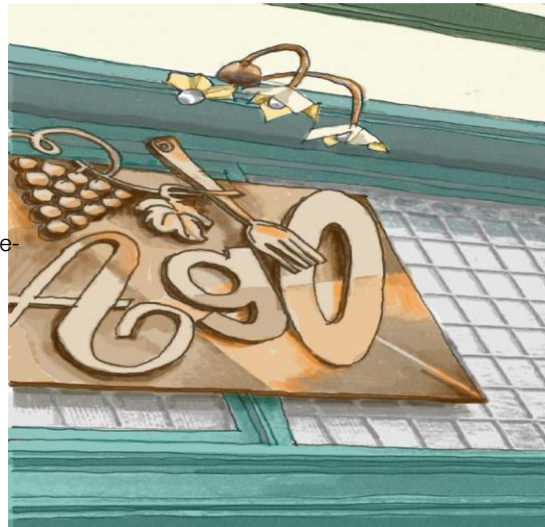

- 222. Avoid the use of exterior fluorescent light sources.
- 223. Install glare-free lighting into the canopy soffit. Fluorescent tube lights are not permitted for this purpose.

DP1.1 COMMON GUIDELINES

BL 18787
BL 19765

SIGN GUIDELINES

Fascia

Within a development, the following elements shall be considered for Sign installations:

- 224. Individually-illuminated channel type letters including internally-illuminated or back-lit solid letters are encouraged. (*Illustr.*) Channel letters should either be flush mounted or mounted on a backer panel.
- 225. Backing for mounting channel letters should enhance the overall character of the building. Use of accent materials such as metal grills and wood should be considered as way to enhance architectural character. (*Illustr.*)



- 226. Individual cut-out signs are supported.
- 227. Backlit box signs with acrylic faces are discouraged; however, where these are used, white or contrasting background colours should be avoided.
- 228. Fascia signs are limited to the first storey only. For buildings with more than two storeys, fascia signs are only permitted on the first and top floor only.
- 229. Dominant fascia signs for a multi-tenant building should brand the building with an identifiable emblem or name of development.
- 230. All fascia signs can use a variety of fonts and styles but should be unified with other signage/building character, should be in scale with the building and should be centred on the façade.
- 231. Figurative graphics, emblems or brand graphics are encouraged singularly or as part of the sign copy. (*Illustr.*)
- 232. Window signs are not permitted above the ground floor.
- 233. Pump island fascia signs are permitted for gas stations only; however, the number of letters and words are restricted to a secondary role.
- 234. Wall plaque signage should be designed for a human scale.
- 235. For multiple tenant sites, ensure there is a coordinate approach to providing fascia signs where there is a clear hierarchy of signs but where anchor tenants do not dominate the first impression of the entire development.
- 236. Building or site addresses are encouraged to be placed at the building entrance and where visible from the street.



DP1.1 COMMON GUIDELINES

BL 18787
BL 19765

SIGN GUIDELINES

Awning or Canopy

Within a development, the following elements shall be considered for Sign installations:

- 237. Awnings or canopies are limited to one prominent sign at unit entrances.
- 238. Awnings are preferred over canopies for use on storefronts less than 10m in length.
- 239. Three-point or four-point awnings are preferred.
- 240. Canopies are preferred over awnings for use on building frontages over 15 m long, where there is significant pedestrian activity or where people need to wait for significant durations.
- 241. Design awnings/canopies should be coordinated with and sympathetic to the style, scale and form of other on-site signage with the sign copy fitting easily onto the face of the awning/canopy for visual continuity. Canopy signs shall not repeat other on-site signs. *(Illustr.)*
- 242. Awnings, canopies and overhangs should incorporate architectural design features and the fenestration patterns (placement of windows and doors) of the buildings they extend from.
- 243. When placing awnings or canopies, the location and size shall minimally obscuring the building façade.
- 244. Transparent and translucent canopies, preferably made of wood or glass, are preferred to allow natural light to penetrate storefronts and the sidewalk.



Under-Awning or Under-Canopy

Within a development, the following elements shall be considered for Sign installations:

- 245. Signs attached to awnings or canopies shall be affixed below and permanently to the awning or canopy structure. Placing signs above the awning is discouraged. *(Illustr.)*
- 246. Under awning or projecting signs are encouraged to be more pedestrian oriented and used as an alternative to sandwich board signs.
- 247. Under awning or canopy signs should be incorporated into the building design to allow for signage flexibility.
- 248. Detailed material treatments (e.g. carvings, routing, layering or sculpting) should also be used for under awning/canopy signs.



DP1.2

Gas Station Guidelines: Residential and Commercial

Guidelines within this section are organized into three different types:

- Residential Areas
- Commercial Centres and
- Highway Commercial Zones

DP1.2 GAS STATION

BL 18787

RESIDENTIAL AREAS

Canopies

The following design elements shall be considered for Gas Stations in Residential Areas:

1. Large/high canopies should be avoided. The underside clearance of the canopy should be minimized. Canopies and any convenience stores located on site should be integrated and physically connected. The size of the canopy should be reduced to fit within a residential neighbourhood by using multiple canopies, different roof forms, off-set canopies, skylights, etc.
2. The setback of the canopy should align with the setback of the buildings on the block.
3. Lighting intensity level should be measured at the surface of the pavement area which is defined by the projection of the canopy and should not exceed 200 lux (20 footcandle). Lighting levels towards the periphery of the site should blend with the illumination level of abutting residential streets. Non-reflective materials should be used and fixtures should be recessed on the underside of the canopy to reduce glare. (*illustr.*)

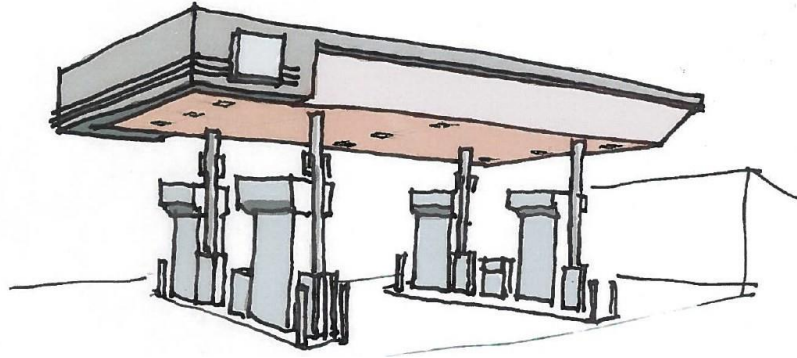

4. Materials for canopies should reflect those used in the immediate residential context (e.g. cedar shingles, glass, wood, brick, etc.).
5. Proportions of the canopy-supporting structure should relate to the size of the canopy. If necessary, sections of the columns should be exaggerated to relate to the canopy.
6. The entire fascia band of a canopy should not be illuminated. Fascia height should be minimized and present a simple profile. The corporate logo should be restricted to two sides of the canopy only. Spot light fascia signage is optional.
7. The form of the canopy should reflect the residential context. Gables and sloping roof lines, thin fascia board, etc. should be used where those elements are present in the immediate residential neighbourhood.

Service Buildings

The following design elements shall be considered for Gas Stations in Residential Areas:

8. Where possible, service building side and rear yard setbacks should be increased to allow for additional landscaped buffering between adjacent properties.
9. Accessory buildings should relate to the size, form and height of the canopy. Integration of buildings is recommended.
10. The same materials should be used for accessory buildings and the canopy. Choose materials of common-use in residential areas (e.g. brick, stucco, wood, etc.). All elevations

DP1.2 GAS STATION

BL 18787

RESIDENTIAL AREAS

Service Buildings *(cont.)*

The following design elements shall be considered for Gas Stations in Residential Areas:

11. Residential roof forms (e.g. sloping, gables, hip roofs, etc.), should be used for the canopy and service buildings. Façade treatment and materials should be consistent on all sides of the building. Use residential-style windows (e.g. mullions and trims).
12. Strategically locate buildings to maximize and facilitate casual surveillance of the site.
13. Provide clear pedestrian linkages to public sidewalks. *(illustr.)*
14. Provide weather protection for pedestrians by building overhangs and canopies. Store entrances should be recessed to allow adequate maneuvering space for wheelchairs in front of the doors.

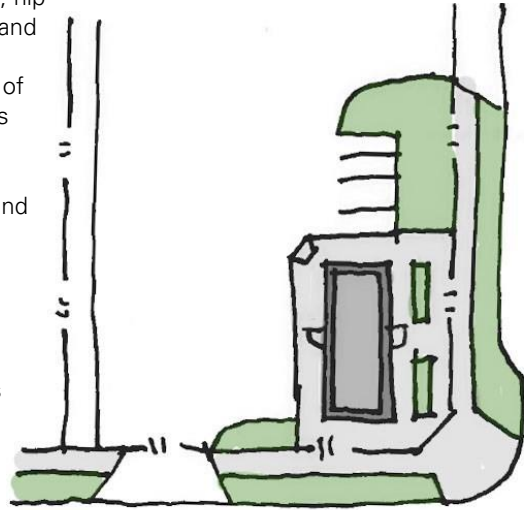

Service Areas

The following design elements shall be considered for Gas Stations in Residential Areas

15. Garbage container enclosures should be of the same materials and finish as the rest of the building and shall have gates. The enclosure should be screened by landscaping and located out of direct view from the street and away from abutting residential properties. *(illustr.)*
16. The garbage container enclosure should be easily accessible by collection vehicles.
17. Outdoor storage is not permitted. Space should be provided inside the convenience store or in a dedicated storage area that is used and integrated with the building. Loading bays should have direct access to the storage areas and be well identified.
18. Underground placement of fuel tanks is required. The tanks should not be located within the required setback.



DP1.2 GAS STATION

BL 18787

RESIDENTIAL AREAS

Driveway Access

The following design elements shall be considered for Gas Stations in Residential Areas:

- 19. The overall site should be planned based on the functional requirements of an average-sized vehicle. Large delivery tanker trucks should be restricted to a dedicated outside lane. Service to trucks should not be provided at these gas stations.
- 20. Minimize the number and width of the entry points to the site to limit open views over the large paved areas. Access driveways to the site should be restricted to one from each of the main abutting streets (e.g. if located on a corner lot, limit to two access points only). *(illustr.)*
- 21. Raised curbs should be used to slow vehicular movement, minimize view corridors of paved areas, and narrow the gap in the continuity of the sidewalk.

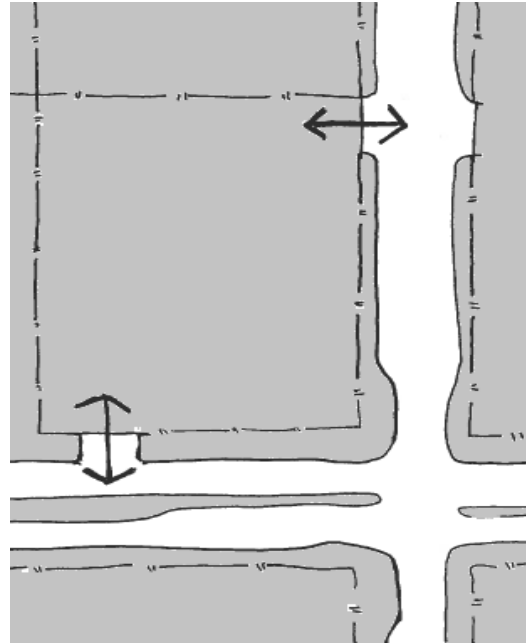

Pavement Standards

The following design elements shall be considered for Gas Stations in Residential Areas:

- 22. Use concrete bands and pavers of contrasting color to break up the areas of asphalt. Areas of asphalt paving should be minimized and landscaping should be increased to be compatible with the landscaping located in the front yard in residential areas.
- 23. Use other types of paving (e.g. contrasting texture and color) to identify customer parking areas, gas pump service areas and pedestrian routes from the sidewalk to the commercial store.
- 24. Use different pavements in combination with landscaped aisles to define vehicular routes and lanes through the site (e.g. a pavement change can identify the 'tanker truck/large vehicle parking lane').
- 25. Concrete sidewalks should be identified across the entry points to the site. A level sidewalk should continue across the upper part of the driveway.

DP1.2 GAS STATION

BL 18787

RESIDENTIAL AREAS

Site Lighting and Signage

The following design elements shall be considered for Gas Stations in Residential Areas:

26. Site lighting should be directed toward the interior of the site. Use landscaping to avoid the impact of reflected light from the canopy, signs and car head lamps onto adjacent sites.
27. Diffuse lighting, focused toward the inside of the site, should be used to minimize the glare towards adjacent properties.
28. One free standing sign per lot frontage will be permitted on the site and must be integrated with landscaping. The sign should be designed as a feature and incorporate materials and forms used in other structures on site. *(illustr.)*



29. Pole signs supported by one or more vertical posts and snap-on signs attached to light fixtures are not permitted.
30. Free standing and monument signs should be located a minimum of 2 m from the street property line to retain visual continuity of the landscaping. A permanent base should also be provided for changeable, temporary signs or advertisements.
31. Wall-mounted signs should be limited to a maximum of two sides of the building. Backlit Plexi-glass box signs, mounted on the fascia of the convenience store, are not permitted. Any box sign must be flush mounted.
32. Corporate logos on the canopy should be limited to a maximum of two sides. Backlit fascia signs are not permitted on any service buildings.

DP1.2 GAS STATION

BL 18787

RESIDENTIAL AREAS

Landscaping

The following design elements shall be considered for Gas Stations in Residential Areas:

33. Retain existing trees at the perimeter of the site and integrate them with the new landscaping to provide a buffer toward adjacent properties and the street.
34. A transitional landscaped area is required along the street, immediately abutting residential areas. This area should decrease in width from 7.5 m at the property line with residential uses to the required 3 m of landscaping along the street.
35. Define the edges of the site with low raised planters, berms, decorative low transparent fences and/or continuous landscaping.
36. Shrubs and trees should be provided along the street. High canopy trees are recommended along the street frontage for security reasons. These trees should be a minimum of 5 cm caliper, planted at 6 m on centre and located within the property line. Some conifers and specimen trees should be provided as accents. "Weeping tree" types are not permitted.
37. For site definition and screening, a 3 m wide landscaped area should be provided along street frontages. Existing trees within this strip should be retained. *(illustr.)*
38. All landscaped areas within the site must be defined by raised curbs. Use these landscaped areas to direct the flow of vehicles on the site and reduce total pavement coverage.
39. High hedges and conifers should be used along areas abutting residential land uses. Feature landscaping should be provided at site entrances and corners. Thorny shrubs are recommended in low visibility landscaped areas to discourage loitering and potential vandalism.

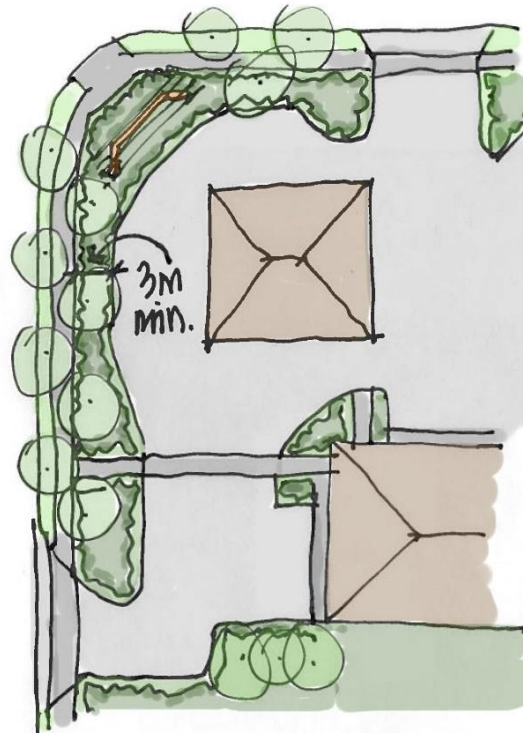

DP1.2 GAS STATION

BL 18787

COMMERCIAL CENTRES

Canopies

The following design elements shall be considered for gas stations in Commercial Centres:

40. Large canopies should be avoided. The use of multiple canopies, glass and thin fascias are strongly recommended to relate to the character of a commercial context. Roof lines and materials should be carefully chosen to respond to potential views from higher points.
41. Canopies should align with the building on the block. In no case should the setback for the canopy be less than 3 m.
42. The size of the canopy should be reduced to its minimum. Underside clearance of the canopy should be no more than 4.2 m and the canopy and convenience stores should be architecturally integrated. Materials should be used that reflect the immediate urban context, (e.g. use metal roofing, canopy skylights and stucco).
43. Roof styles (e.g. stepped, sloped and partial flat forms) should be used to reflect a mixed-use context and should improve potential views from above. Apparent size of the canopy structure should relate to the scale and design of the buildings in the immediate context. The use of multiple canopies, ex-posed space-frame structures and off-set canopies should be considered.
44. Properties of the support structure should relate to the apparent size of the canopy. If necessary, the support structure should be exaggerated to relate to the size of the canopy.
45. The fascia profile should be simple and its height should be minimized. Consider alternative design solutions (e.g. using a shed roof, skylights or discontinuous fascia bands). Backlighting of the entire fascia is not permitted. Spotlighting or neon signs are acceptable on a site-specific basis.
46. Lighting intensity level, measured at the surface of the pavement area defined by the projection of the canopy should not exceed 300 lux (30 footcandle). Lighting levels towards the periphery of the site should not exceed those established for the City Centre or for commercial zones. Using non-reflective materials and recessed lighting on the underside of the canopy is recommended. *(illustr.)*

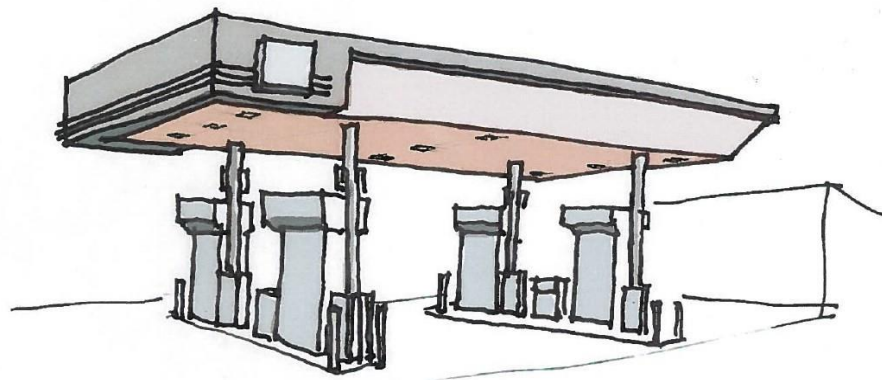

DP1.2 GAS STATION

BL 18787

COMMERCIAL CENTRES

Service Buildings

The following design elements shall be considered for gas stations in Commercial Centres:

- 47. Setbacks should be consistent with abutting land use yard requirements, for example, no side yard setback in a block of continuous commercial frontage.
- 48. Accessory buildings should relate to the size and height of the canopy. At certain locations, a larger and taller accessory building may be desirable to relate to the commercial context. Where appropriate, the commercial component should be located toward the corner of the site to maintain the continuity of building frontage.
- 49. Similar materials should be used in the canopy of service buildings. Choose materials used in commercial areas (e.g. glass, metal and stucco). All elevations should be consistent in the use of materials.
- 50. Commercial roof forms should be used for the canopy and the convenience store and/or service buildings. Façade treatments should be consistent on those sides of the building exposed to views. Weather protection should be provided for pedestrians around the convenience store and service buildings. Commercial window types are desirable.
- 51. Maximize window areas for casual surveillance and increased visibility of both staff and customers.
- 52. Backlit fascia signs or canopies of the convenience store and/or service building are acceptable if compatible with the immediate context.

Service Areas

The following design elements shall be considered for Gas Stations in Commercial Centres:

- 53. A covered enclosure, with gates, should be provided for the garage containers to avoid exposure to views from the street and from above. This enclosure should be located away from direct views from the street and should be built of the same materials and finish as the rest of the building. Landscaped screening may be appropriate. *(illustr.)*
- 54. Commercial and/or service buildings should include a separate room for the storage of goods with direct access from the outside. The loading and unloading area should be well identified with contrasting pavement. Outdoor storage is not permitted.
- 55. Storage areas and garbage container enclosures should be located for ease of access by delivery and collection vehicles.
- 56. Any fuel tank should be located under- ground and outside the setback area.



DP1.2 GAS STATION

BL 18787

COMMERCIAL CENTRES

Driveway Access

The following design elements shall be considered for Gas Stations in Commercial Centres:

- 57. Site layout should be based on the functional requirements of an average-sized vehicle. Large delivery trucks should be restricted to a dedicated or outside lane.
- 58. Minimize the number and the width of the entry points to the site to limit open views over the large paved areas. Access drive- ways to the site should be restricted to two from the primary street and to one from the secondary street. Access drive- ways should be located as far away from the intersection as possible. *(illustr.)*
- 59. Raised curbs should be used to slow vehicles entering the site, minimize the interruption of the sidewalk and reduce views toward the paved areas.

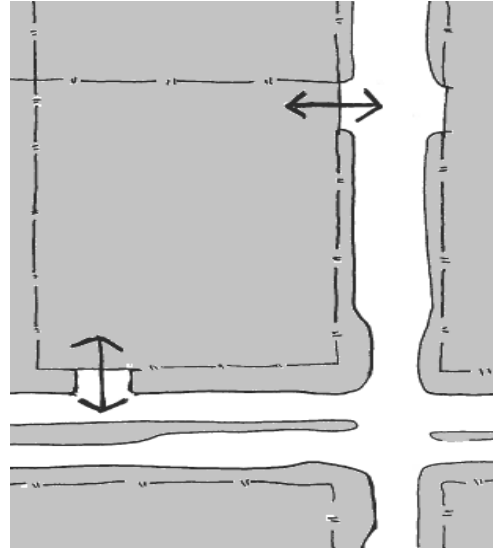

Pavement Standards

The following design elements shall be considered for Gas Stations in Commercial Centres:

- 60. Break up the asphalt areas with concrete bands and/or pavers of contrasting color to reduce the impact of large paved areas viewed from above.
- 61. Use other types of paving (e.g. contrasting texture and color) to identify customer parking areas, gas pump service areas and pedestrian routes from the sidewalk to the commercial store. *(illustr.)*
- 62. Continuity of the public sidewalk should be maintained and reinforced across drive- ways to the site by using contrasting pavement.

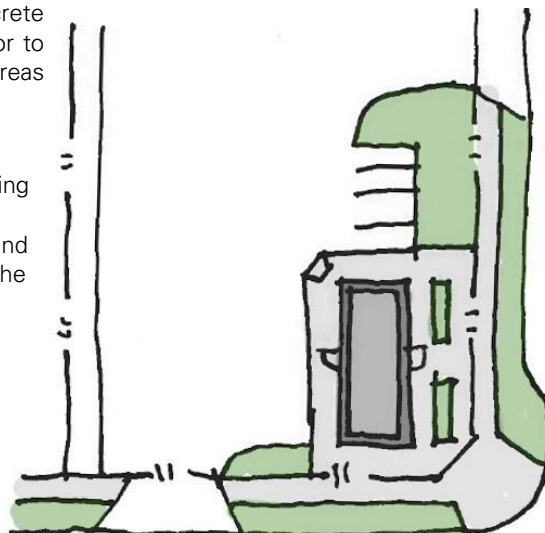

DP1.2 GAS STATION

BL 18787

COMMERCIAL CENTRES

Site Lighting and Signage

The following design elements shall be considered for Gas Stations in Commercial Centres:

- 63. All lighting should be directed toward the interior of the site.
- 64. It is recommended that diffused lighting, focused toward the inside of the site, be used to soften glare and spillage over adjacent properties.
- 65. One (1) monument sign should be provided for identification purposes and should be integrated with the landscaping. Signs should use the form and materials found in other structures on the site. Other signs are not permitted. *(illustr.)*
- 66. Monument signs should be located a minimum of 2 m from the street property line or at the building line, where the streetscape requires that a continuous street frontage be maintained. A permanent base should also be provided for changeable temporary signs to avoid the unplanned proliferation of spontaneous advertisement.
- 67. Corporate logos on the canopy should be limited to two sides.
- 68. Signage for the commercial/service buildings should relate to the signs used in the commercial context and shall be limited to two sides of the building. Backlit-Plexiglas wall-mounted signs are not permitted. Illuminated single channel letters, mounted directly on the fascia or wall, are recommended.



Landscaping

The following design elements shall be considered for Gas Stations in Commercial Centres:

- 69. Some of the existing trees on the perimeter of the site may be identified for retention and integrated with new tree and shrub planting along the boulevards.
- 70. A transitional area made up of a combination of soft and hard landscaping, should be provided toward the street frontage in areas abutting adjacent land uses.
- 71. At Town Centres or in the City Centre, low, raised landscaped planters and low, decorative fences, in combination with general landscaping, should be used for site definition to maintain the more formal streetscape character. In these specific areas, the width of the landscaped area may be narrower.

DP1.2 GAS STATION

BL 18787

COMMERCIAL CENTRES

Landscaping (cont.)

The following design elements shall be considered for Gas Stations in Commercial Centres:

- 72. Shrubs, in combination with high canopy trees, should be provided along the street frontage to complement boulevard trees. These trees should be 5 cm caliper, planted at 6 m on centre, and located within the property line. Some conifers and specimen trees should be provided as accents. "Weeping" tree types are not permitted.
- 73. A 3 m wide landscaped area should be provided along street frontages for site definition and screening of views toward the site. In some locations, retention of existing trees may be appropriate. *(illustr.)*
- 74. Landscaped areas defined by a raised curb should be provided within the site. These islands should be used to direct the flow of vehicles through the site and to soften the paved areas.
- 75. Landscaping should reflect the urban character of the area. Low hedging and shrubs of a regular height (approximately 1 m) is recommended along the street. Deciduous trees should be planted in groups as accents on the site. Overall landscaping concepts should be coordinated with the landscaping on abutting land uses and buildings forms (e.g. from above views).
- 76. If required, solid, high-quality fencing, or low walls in combination with landscaping, should be provided along the inside of property lines. Materials should be compatible and coordinated with the materials used on the buildings on-site.

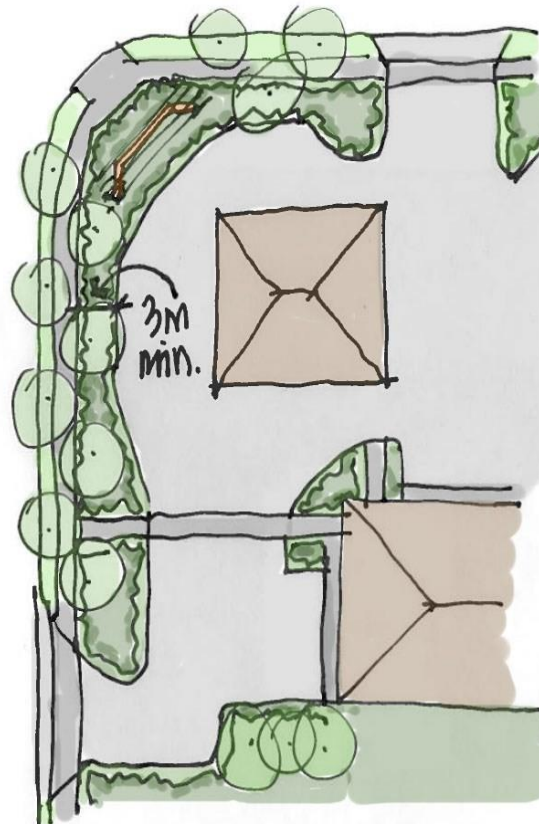

DP1.2 GAS STATION

BL 18787

HIGHWAY COMMERCIAL ZONES

Canopies

The following design elements shall be considered for Gas Stations in Highway Commercial Zones:

- 77. Support the importance of the canopy as a building landmark element by making the canopy a component of a larger commercial development. The canopy should incorporate or maintain coordination with the dominant forms of the building that define its background.
- 78. The minimum setback should be 7.5 m from the front property line. Reduced setbacks can be provided under a Comprehensive Development zoning supporting Highway Commercial uses.
- 79. Canopies and convenience stores should physically be linked and coordinated in scale with other buildings that form part of the complex.
- 80. Lighting intensity level, measured at the surface of the pavement area defined by the projection of the canopy should not exceed 300 lux (30 footcandle). Lighting levels towards the periphery of the site should not exceed those established for the City Centre or for commercial zones. Using non-reflective materials and recessed lighting on the underside of the canopy is recommended. *(illustr.)*

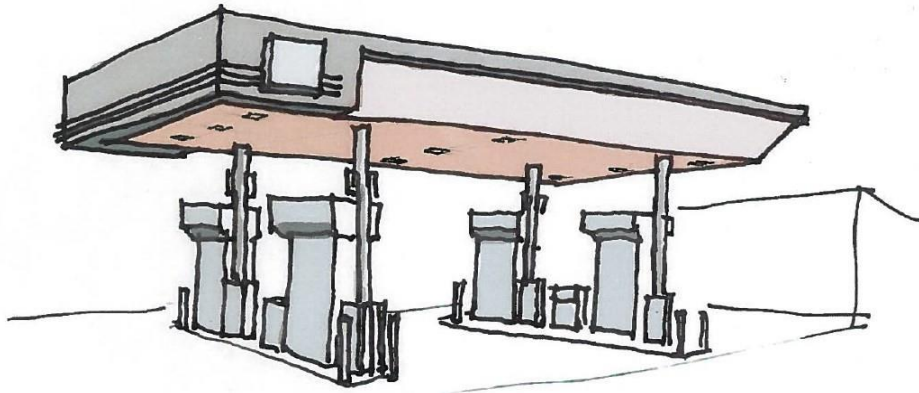

- 81. Roof form construction is required among the various buildings on the site. Apparent size of the canopy structure should relate to the scale and design of the buildings in the immediate context. Where appropriate, links between the canopy and the commercial component of the project should be consistent. Coordination of materials with adjacent buildings is required.
- 82. Proportions of the canopy support structure should relate to the apparent size of the canopy; if necessary, the support structure should be exaggerated to relate to the size of the canopy.
- 83. Fascia should relate to other buildings on the site. Corporate logos should be restricted to two sides of the canopy only. Backlighting the entire fascia is not permitted.

Service Buildings

The following design elements shall be considered for Gas Stations in Highway Commercial Zones:

- 84. Accessory buildings should relate to the size and height of the canopy and other buildings on the site. Similar materials should be used for the canopy and accessory buildings.
- 85. Maximize and strategically locate window areas for casual surveillance of the site. Backlit fascia/ canopies are acceptable if compatible with the immediate context.

DP1.2 GAS STATION

BL 18787

HIGHWAY COMMERCIAL ZONES

Service Buildings (cont.)

The following design elements shall be considered for Gas Stations in Highway Commercial Zones:

- 86. Commercial roof forms should be used for the canopy, the convenience store, accessory buildings and other components of the site. Façade treatment and materials should be consistent on all sides of the buildings exposed to views. Provide weather protection for pedestrians along the convenience store frontage and other buildings on site. Covered, direct pedestrian links amongst buildings is encouraged. Recess entrance doors to the convenience/retail store for easy maneuvering of wheelchairs.

Driveway Access

The following design elements shall be considered for Gas Stations in Highway Commercial Zones:

- 87. Layout should permit easy access and egress and internal maneuvering of vehicles on the site. Service of trucks and large vehicles should be restricted to a dedicated or outside lane.
- 88. Access driveways are limited to two from the road. The site layout should aim to minimize the width and number of the entry points to the site. Access driveways should be located as far away from the intersection as possible. *(Illustr.)*
- 89. Wherever possible, raised curbs should be used at the entrance to the site. Flared let-down access points are recommended where vehicular ease of access is a concern.

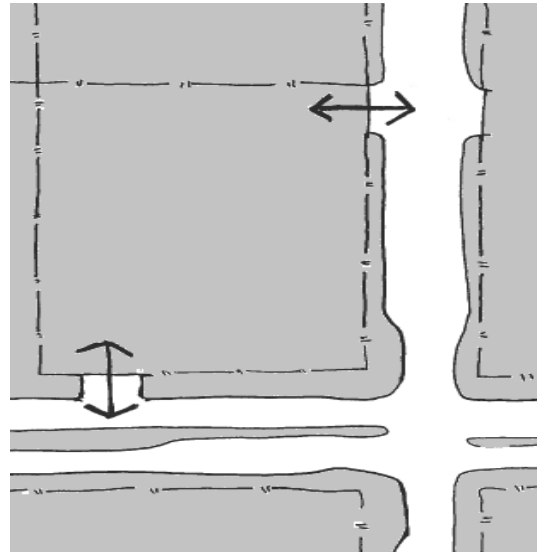

Pavement Standards

The following design elements shall be considered for Gas Stations in Highway Commercial Zones:

- 90. Break up asphalt areas with concrete bands at site entrances and at specific functional areas to reduce the impact of large paved areas.
- 91. Use different pavement materials to identify functional areas of the site (e.g. customer parking, pedestrian routes to retail commercial buildings and amongst buildings on the site).
- 92. Use contrasting color and textured pavement and landscaped aisles to identify vehicular and pedestrian movements through the site.

DP1.2 GAS STATION

BL 18787

HIGHWAY COMMERCIAL ZONES

Service Areas

The following design elements shall be considered for Gas Stations in Highway Commercial Zones:

- 94. Garbage container enclosures should be of the same materials and finish as the rest of the building and shall have gates. The enclosure should be screened by landscaping and located out of direct view from the street and away from abutting residential properties. *(illustr.)*
- 95. Outdoor storage areas are not permitted.
- 96. Fuel (including propane) tanks should not be located within the required setback. Visibility toward the tanks should be minimized by providing a substantial landscaping berm. Vertical positioning of the tanks should be avoided.

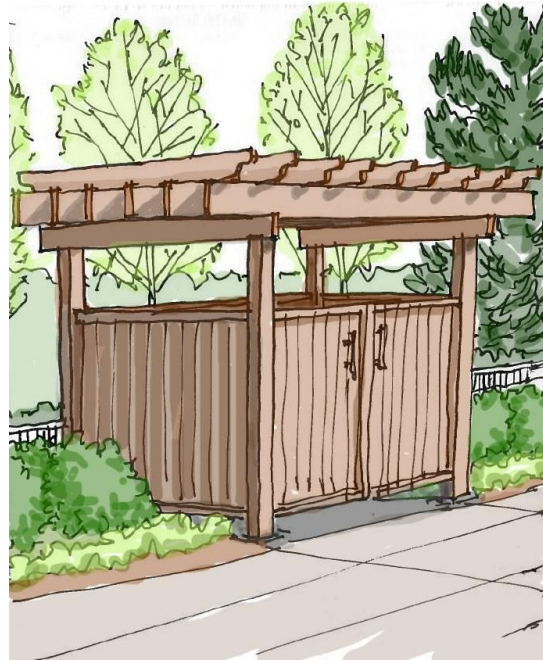

Site Lighting and Signage

The following design elements shall be considered for Gas Stations in Highway Commercial Zones:

- 97. Freestanding signs, without a single pole, should be integrated with the landscaping and provide with a strong base. Signs should use the materials and forms found in other structures on the site or in the immediate area. The use of a sign as a feature landmark along the highway is encouraged.
- 98. Signs should be located a minimum of 2 m from the front property line. A permanent base should also be provided for changeable temporary signs. Corporate logos on the canopy should be limited to two sides.
- 99. Signage for the accessory/commercial buildings on site and for gas station signage should be coordinated. Backlit Plexiglas fascia-mounted signs are not permitted unless they constitute a continuous fascia band. Backlit channel letters are recommended. Surface-mounted box signs are not permitted.
- 100. Lighting of the site should be directed toward the interior and should be consistent throughout the development.
- 101. It is recommended that diffused lighting, focused toward the interior of the site, be used to reduce glare over adjacent properties.

DP1.2 GAS STATION

BL 18787

HIGHWAY COMMERCIAL ZONES

Landscaping

The following design elements shall be considered for Gas Stations in Highway Commercial Zones:

- 102. For site definition and screening, a 3 m wide landscaped area should be provided along street frontages. Existing trees within this strip should be retained and incorporated into the new landscaping. *(illustr.)* Coniferous trees should be planted in this area.
- 103. A front yard transitional area with substantial landscaping should be provided in the area immediately abutting adjacent sites.
- 104. A combination of low berm or low feature wall and landscaping should be considered along the street, or highway frontage of the site. No solid fences are permitted along a street.
- 105. Landscaping should reflect the car-oriented character of the area. Deciduous trees, with conifer accents, should be planted along the street frontage. High canopy trees located within the property line should be considered along the highway frontage.
- 106. All existing trees at the perimeter of the site should be retained and integrated with new tree and shrub planting.
- 107. Landscaped areas provided within the site should be defined by a raised curb. These islands should be used to direct the flow of vehicles throughout the site.
- 108. Deciduous trees should be planted on the interior of the site and side yard to achieve a certain degree of integration with adjacent developments. Thorny shrubs should be considered in isolated areas which are hidden from surveillance and may be subject to potential vandalism.
- 109. No solid fences are permitted. If required, low transparent fences, in combination with landscaping, are recommended. The fence should permit pedestrian movement between sites.

